



# INQUEST

RESEARCH JOURNAL OF TARLAC STATE UNIVERSITY  
VOLUME 11, NO. 1, DECEMBER 2018

ISBN# 2094-6864



# INQUEST



RESEARCH JOURNAL OF TARLAC STATE UNIVERSITY

ISBN# 2094-6864

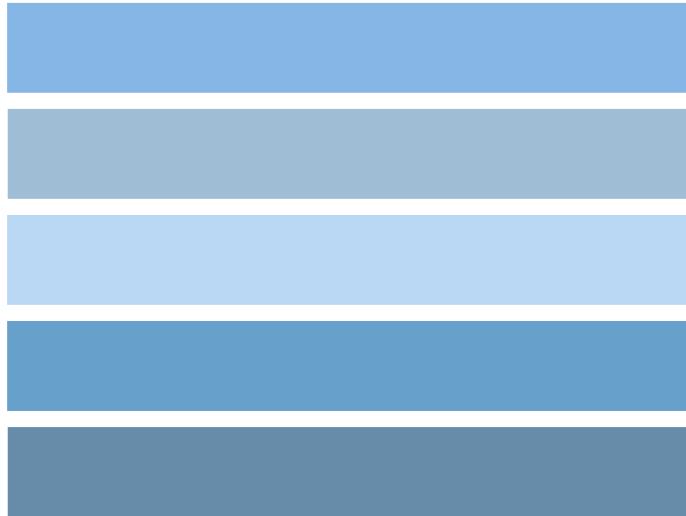

This issue was published on  
December 2018 as  
Volume 11 Number 1



**OFFICE ADDRESS:**

Research, Extension and Development (RED) Building  
Villa Lucinda Extension Campus - Tarlac State University  
Brgy. Binauganan, Tarlac City  
Philippines

Fax: (6345) 982-0110

E-mail address: [research@tsu.edu.ph](mailto:research@tsu.edu.ph)

COVER DESIGN BY: DORINE MAE B. BIAG



“In the university’s pursuit to be the center of development in science and technology and higher education, we need to be relevant, we need to contribute to local and national development programs, we need to continuously seek new knowledge, we need to harness to the fullest the limited resources we have, we need to empower the human resources and strengthen unity and teamwork.”

**- Introduction to the Operational Framework and Challenges of the Tarlac State University**

# EDITORIAL BOARD



Editor in Chief  
**DR. MYRNA Q. MALLARI**



Mathematics and Statistics Specialist  
**DR. LOLITA V. SICAT**



History and Culture Specialist  
**DR. LINO L. DIZON**



Social Sciences and Education Specialist  
**DR. GLENARD T. MADRIAGA**



Science and Technology Specialist  
**DR. LEO P. PIAO**



Managing Layout Editor  
**MS. DORINE MAE B. BIAG**



English Language Editor  
**DR. CECILIA L. CALUB**

# TABLE OF CONTENTS

<p><b>GIS-based Liquefaction Potential Analysis: A Seismic Hazard Mapping of Tarlac Province, Philippines</b></p> <p>Marie Wendy J. Frany Edwin L. Dela Vega</p>	03
<p><b>Evaluation of School-Based Feeding Program : Towards the Development of the TRAC Feeding Program Model</b></p> <p>Alma M. Corpuz Cynthia, G. Quiambao</p>	11
<p><b>Ang Programang Filipino ng mga Pang-Estadong Unibersidad at Kolehiyo sa Rehiyon III: Batayang Pag-aaral tungo sa isang Akademikong Modelong Pangwika</b></p> <p>Dexter L. Manzano</p>	25
<p><b>Exploring Mental Health Stigma and its Relationship to College Students' Help-Seeking Behavior</b></p> <p>Laarni T. Capinding Daniel T. Dizon Editha Q. Villavicencio</p>	41
<p><b>Segmenting Tarlacqueño-Consumers: An Analysis</b></p> <p>Wilmarm J. Ramos</p>	49
<p><b>Development of integrated Administrative Management System: Procurement Module for Tarlac State University</b></p> <p>Heidilyn V. Gamido</p>	57
<p><b>Electric Vehicle with Backup Solar Charger Research Project</b></p> <p>Leo P. Piao, Raul D. Canlas Adam F. Rombaoa, Arnel A. Punla, Bernardino P. Nalipay, and Jessie H. Domingo</p>	67
<p><b>WebApp for Energy Management System</b></p> <p>Ronnie B. Mercado Dennis Y. Virtudazo Valerie D. Simbol</p>	73
<p><b>The Use of Edmodo with Journal Writing in Teaching Mathematics</b></p> <p>Nelvin R. Nool Jessie B. Aquino</p>	79

# GIS-based Liquefaction Potential Analysis: A Seismic Hazard Mapping of Tarlac Province, Philippines

Marie Wendy J. Frany and Edwin L. Dela Vega  
Civil Engineering Department  
College of Engineering and Technology  
Tarlac State University

**Abstract:** Liquefaction induced failure is one of the major concerns in geotechnical engineering which resulted to tremendous damage in civil structures. Areas with high ground water levels and alluvial soils have high risk for liquefaction damage, especially in seismically active regions. This liquefaction phenomenon has brought devastating impact on Pangasinan and Tarlac provinces during the July 1990 Central Luzon earthquake. This study determines the liquefaction potential of Tarlac province based on the geotechnical profile of the underlying soil formation. The study was outlined into: transformation of Geotechnical Investigation Reports (GIR) from the different engineering offices in Tarlac province into geographical data; computation of the Liquefaction Potential Index (LPI) at the borehole sites using Seed and Idriss method and GIS-Based liquefaction susceptibility mapping of the province at earthquake magnitudes of 5.0, 6.0 and 7.5. The LPI were determined from the GIR's and processed using MathCAD software. The GIS software is used in converting and analysing the LPI results. At magnitude 5.0 only parts of La Paz, Victoria and Tarlac city are vulnerable to liquefaction. At magnitude 6.0 – 7.5, the three municipalities have higher risk to liquefaction including parts of Gerona, Capas, Bamban, San Jose and Concepcion. Hence, GIS based mapping of the severity of liquefaction potential of the municipalities in Tarlac province at different earthquake magnitudes will be useful in evaluating counter measures to mitigate or reduce the effects of soil liquefaction on civil engineering structures. The hazard maps will provide critical information in land use planning and zoning and in disaster risk management of the local government units of every municipality of Tarlac.

**Keywords:** liquefaction potential, geotechnical investigation report, GIS-based, hazard map, Tarlac

## 1. Introduction

Infrastructure development is evident with the construction of skyscrapers and high rise buildings on highly urbanized areas of the country. With the anticipated development and build up in infrastructure, the direction of country's civil infrastructure nowadays is focused on the development of marginal lands. This will inevitably involve some risks which are geotechnical in nature and most likely liquefaction of vulnerable areas.

The liquefaction phenomena as a major secondary effect of the July 16, 1990 Central Luzon earthquake of magnitude 7.8 has devastating impact in Pangasinan and Tarlac provinces where surface soils are vulnerable to liquefaction. The damage created in the provinces and the danger of liquefaction is an indication of the need to provide engineered responses to mitigate the risk of the phenomena.

Susceptibility of Tarlac province is evident on studies made on liquefiable areas that were focused on geographic location and geologic information. A particular study made by Torres et al (2001) from Philippine Institute of Volcanology and Seismology -DOST and National Institute of Geological Sciences – UP, were based on the underlying geological and sedimentological constraints on the occurrence of liquefaction. Back swamps in Gerona, Pura, Ramos and Paniqui in Tarlac province is one of the recognized types of site vulnerable to liquefaction. The study made on the susceptibility of Gerona, Tarlac to liquefaction based on geotechnical investigation of the borehole sites in the area is benchmarked on this study. According to Dela Vega (2016), at earthquake of magnitude 7.5, all areas near the test sites are found to be highly susceptible at a depth of 4.5m to 7.5m except for one site which has moderate liquefaction potential.

Using the standard penetration test (SPT) N-value, this study will determine the liquefaction potential index (LPI) at borehole sites using the method of Seed and Idriss (1971) and the criteria proposed by Iwasaki et al (1982). Other procedures for liquefaction predict soil at certain depth will liquefy but not the severity of liquefaction manifestations. The LPI will assess the damage potential of liquefaction by accounting the characteristics of soil at different depths.

The study also aims to create a geodatabase of the borehole data. Since problems of natural disasters are best understood spatially, this study will provide a GIS-based liquefaction potential map of the Tarlac province at earthquake magnitudes of 5.0, 6.0 and 7.5 using GIS ArcMap 10.2.1 software. These maps are useful tools for identifying the degree of susceptibility of areas to liquefaction-induced ground deformation.

## 2. Methodology

### 2.1. Geographic transformation of soil test sites

Foundation and geotechnical engineers made subsurface soil investigations in order to provide adequate information for design usage. The bore log reports are required, submitted and kept at government engineering offices as part of project requirements and permits. These geotechnical investigation reports (GIRs) gathered from different engineering offices of the province includes information on the boring depth, unit weight of soil, SPT N-value and fines content of soil passing through sieve no. 200. There were ninety three (93) borehole data sites identified in the province. The geographical coordinates of these specified SPT locations from the bore log reports were established using the GPS map camera and transformed into a shapefile in ArcMap as shown in Figure 1.

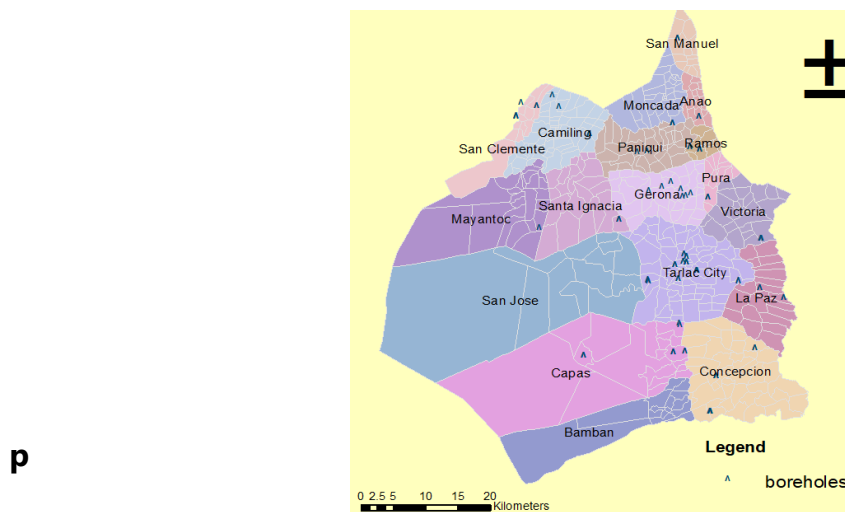

**Figure 1.** Map of Tarlac province showing soil penetration test sites

### 2.2 Liquefaction potential analysis

Generally, the LPI accounts for the probability that a soil will liquefy and the cumulative response of the soil deposit to liquefaction. According to Dixit et al (2012), LPI is a single-valued parameter to evaluate regional liquefaction potential. The LPI at a site is computed by integrating the factor of safety (FS) along the soil column up to 20 m depth. Iwasaki et al (1978, 1982) proposed the LPI at each SPT site given in equation 1. The functions and values associated with equation 1 and the LPI assessment criteria are summarized in Table 1.

$$LPI = \int_0^{20} F \cdot w(z) dz$$

Soil liquefaction characteristics depend on several factors such as the grain size distribution, ground acceleration, soil density, thickness of soil deposit and position of the ground water table. Ground failures and liquefaction are commonly associated with large magnitudes. The thickness of underlying liquefiable soil is directly related to post liquefaction failures. Hence, thicker liquefiable strata would mean an area more prone to liquefaction. (Tosun et al, 2011; Orourke and Pease, 1997; Sladen et al, 1985)

**Table 1.** LPI functions, values and assessment criteria (Iwasaki et al, 1982)

F	FS	w(z)	z value
1 - FS	FS < 1	$10 - 0.5z$	$z < 20$
0	FS > 1	0	$z > 20$
LPI criteria		LPI value	
low		$0 < LPI \leq 5$	
moderate		$5 < LPI \leq 15$	
high		$LPI > 15$	

The ground water level has great influence in LPI calculation according to ZillurRahman et al (2015). It is more likely that LPI value and percentage of area showing liquefaction manifestation will increase if the ground water levels considered in the analysis are based on monsoon. Moreover, areas developed in reclaimed land along sea or creek shore are prone to liquefaction potential (Mhaske and Choudhury, 2010).

**2.3. Evaluation of factor of safety (FS)**

FS defined by Seed and Idriss (1971) is the based on the capacity of a soil element to resist liquefaction and the seismic demand imposed on it. The capacity to resist liquefaction is referred to as the cyclic resistance ratio (CRR) and the seismic demand as the cyclic stress ratio (CSR). The factor of safety is defined in equation 2.

$$FS = \frac{CRR}{CSR} \tag{2}$$

Evaluation of the soil resistance capacity along the depth of soil profile requires the raw data SPT N-value, ( $N_{SPT}$ ) be corrected with an assumption that 60% of the energy is transferred from the falling hammer to the SPT soil sampler. The corrected value of the blow count ( $(N_1)_{60}$ ) is evaluated in equation 3. The  $N_{SPT}$  correction factors for overburden  $C_N$ , for hammer energy ratio  $C_E$ , for diameter of boreholes  $C_N$ , for length of sampling rod  $C_R$ , and type of sampler  $C_S$  are given in equations 4 and 5.

$$(N_1)_{60} = N_{SPT} \cdot C_N \cdot C_E \cdot C_B \tag{3}$$

$$C_N = \sqrt{\frac{P_{ATM}}{\sigma}} \tag{4}$$

$$C_E = \frac{ER}{60} \tag{5}$$



$$(N_1)_{CS60} = (N_1)_{60} + \Delta(N_1)_{60} \quad (6)$$

$P_{ATM}$  is 1atm = 100kPa of overburden. The actual energy ratio (ER) delivered to the top of drill rod is taken as 45 since the hammer used is a donut-type with a hammer-pulley release.  $C_B = 1.0$  for borehole diameter ranging from 65 to 115 mm.  $C_S = 1.2$  for samplers without a liner. The correction for sampling rod,  $C_R$  varies with the sampling depth,  $z$ . CRR also requires fines content (FC) (percent finer than 0.075 mm or no. 200 sieve )of the soil to convert  $(N_1)_{60}$  to an equivalent clean sand resistance value  $(N_1)_{CS60}$  given in equation 6. The correction value for  $C_R$  and  $D(N_1)_{60}$  are presented in Table 2.

**Table 2.** Correction value for sampling rod and fines content (Seed and Idriss, 1982)

sampling depth, $z$ (m)	$C_R$ value	fines content (FC)	$D(N_1)_{60}$ value
$z \leq 3$	0.75	$FC \leq 5\%$	0
$3 < z < 9$	$(15 + z)/24$	$5\% < FC < 35\%$	$7(FC-5)/30$
$z \geq 9$	1.0	$FC \geq 35\%$	7.0

The cyclic resistance ratio (CRR) for an earthquake magnitude,  $CRR_{M=7.5}$  was then computed from equation 7.

$$100CRR_{M=7.5} = \frac{95}{34 - (N_1)_{CS60}} + \frac{(N_1)_{CS60}}{1.3} - \frac{1}{2} \quad (7)$$

For  $(N_1)_{CS60}$  value exceeding 30, CRR approaches infinity which corresponds to a very dense sandy soil where liquefaction is unlikely to occur. More so, a magnitude scaling factor (MSF) is used to adjust  $CRR_{M=7.5}$  for the magnitude of earthquake under consideration. The resulting CRR is expressed in equation 8 and the MSF value is obtained using equation 9 or equation 10 depending on the earthquake magnitude, ( $M_w$ ).

$$CRR = (CRR_{M=7.5})(MSF) \quad (8)$$

$$MSF = (M_w^{-3.46})(10^{3.0}) \quad \text{for } M_w < 7.0 \quad (9)$$

$$MSF = (M_w^{-2.56})(10^{2.24}) \quad \text{for } M_w \geq 7.0 \quad (10)$$

The cyclic stress ratio, CSR, is evaluated to determine average cyclic shear generated by an earthquake of specific magnitude. The CSR is given by equation 11.

$$CSR = 0.65 \left( \frac{\alpha_{max}}{g} \right) \left( \frac{\sigma_{vo}}{\sigma'_{vo}} \right) r_d \quad (11)$$

The uniform cyclic stress required to generate pore water pressure during an earthquake is accounted by the weighing factor 0.65. Other values in equation 11 are the peak horizontal ground acceleration ( $\alpha_{max}$ ), the gravitational acceleration ( $g$ ), the total vertical ( $\sigma_{ov}$ ) and effective ( $\sigma'_{ov}$ ) overburden stress at a given depth below the ground surface and  $r_d$  is the depth dependent stress reduction factor.

## 2.4. GIS-based LPI analysis and mapping

The established geographical coordinates of the borehole sites were stored and analyzed in ArcMap 10.2.1. The geographic data of the municipalities were downloaded from <https://www.philgis.org>. All the geographic data were projected to WGS\_1984 UTM Zone 51N coordinate system.

The MathCAD LPI results at the borehole sites were interpolated over the area using the Inverse Distance Weighted (IDW) method. The capability of the ArcMAP 10.2.1 was used in interpolating the liquefaction potential indexes. The interpolated contours of LPI values was reclassified in ArcMap using the criteria proposed by Iwaski et al (1982) to come up with a liquefaction potential map for the different earthquake magnitudes of 5.0, 6.0 and 7.5.

### 3.0. Results and Discussion

The liquefaction maps and LPI contour maps of Tarlac province at earthquake magnitudes of 5.0, 6.0, and 7.5 are shown in Figure 2, Figure 3 and Figure 4, respectively. At earthquake magnitude of 5.0, the liquefaction potential of most of the towns are low. Based on ArcMap spatial analysis, approximately 12% of La Paz land area, 34% of Victoria and 10% of Tarlac city land area will have moderate liquefaction potential and less than 1% of the Gerona and Camiling land area will have moderate liquefaction potential. This is approximately 76 square kilometres in area and the rest of the province will have low potential. At earthquake magnitude of 6.0, approximately 14% of Gerona land area will have high liquefaction potential including Tarlac city, La Paz and Victoria. At this magnitude, 36% of Tarlac province total land area will have low liquefaction potential, 62% moderate and 2% will have high liquefaction potential.

As shown in Figure 4, the liquefaction potential map of Tarlac province indicates that at earthquake magnitude of 7.5, 66% of the total land area of the province (approximately 2,000 square kilometres) will have moderate liquefaction potential and 34% (approximately 1,000 square kilometres) will have high liquefaction potential. This showed that the highly critical areas comprised the whole town of La Paz, 59% of its land area for Victoria, 59% of Tarlac city, 66% of Gerona, 86% of Capas, 30% of Anao and 26% of Concepcion town area.

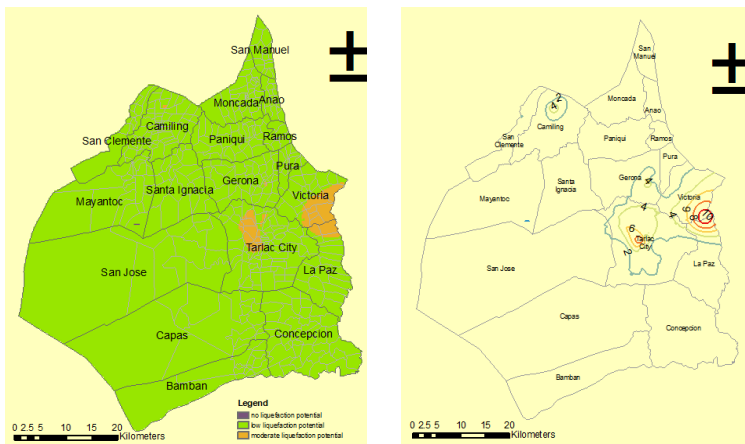

**Figure 2.** Liquefaction potential map of Tarlac province at earthquake magnitude 5.0 (on the left) and LPI contour map (on the right).

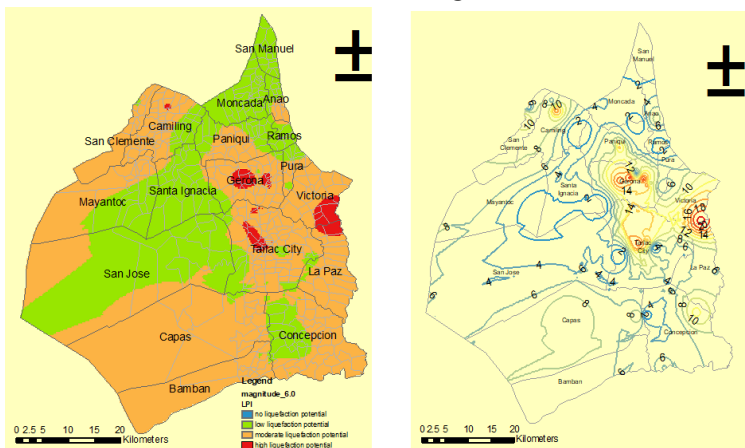

**Figure 3.** Liquefaction potential map of Tarlac province at earthquake magnitude 6.0 (on the left) and LPI contour map (on the right).

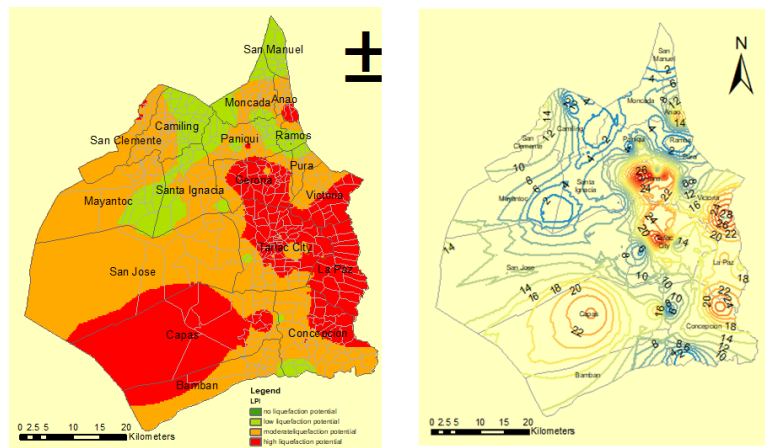

**Figure 4.** Liquefaction potential map of Tarlac province at earthquake magnitude 7.0 (on the left) and LPI contour map (on the right).

#### 4. Conclusions

The liquefaction potential of Tarlac province at different earthquake magnitudes was effectively analyzed and processed using the MathCad program. The LPI results are best described in space using the GIS-based data processing and analysis. At magnitude 5.0 only parts of La Paz, Victoria and Tarlac city are vulnerable to liquefaction. At magnitude 6.0 – 7.5, the three municipalities will have higher risk to liquefaction including parts of Gerona, Capas, Bamban, San Jose and Concepcion. Most of these areas are within the alluvial complex of the river system within the province and can be verified in Google earth.

Maps are effective visual representations of geographic information like seismic hazard. The re-classification of LPI values according low, moderate and high liquefaction potential provides a clearer concept of the seismic hazard understood by the common people. The contour maps are useful in design considerations. These seismic hazard maps can be detailed by municipalities for their land use planning and zoning. Detailing of the results within barangays will also benefit government agencies on disaster risk management.

#### 5. Acknowledgements

This work was supported by Tarlac State University Research Office. The authors also wishes to thank the assistance of their colleagues, students, the municipal engineers of the province, and the department heads of the district engineering offices of the Department of Public Works and Highways.

#### References

- Dela Vega, E. (2016). Liquefaction Susceptibility Plot of Gerona, Central Luzon Philippines Liquefaction Susceptibility Plot of Gerona, Central Luzon Philippines *International Journal of Structural and Civil Engineering Research* vol. 5 - No.4
- Dixit, J., Dewarkov, D., Jangid, R. (2012). Assessment of liquefaction potential index for Mumbai city. *Natural Hazards and Earth System Sciences*, pp 2759 – 2768.
- Iwassaki, T., Tokida, K., Tatsuoka, S., Sato, H. (1982). Micronization for soil liquefaction potential using simplified methods. *Proceedings of 2<sup>nd</sup> International Conference on Micrinization*. Seattle, pp 1319 – 1330
- Mhaske, S., Choudhury, D. (2010). GIS-based soli liquefaction susceptibility map of Mumbai city for earthquake events. *Journal of Apllied Geophysics*, pp 216 – 225.

Orouke, T., Pease, J. (1997) Mapping Liquefiable Layer Thickness for Seismic Hazard Assessment. *Journal of Geotechnical and Geoenvironmental Engineering*. ISSN 1090-0241 Vol. 123, Issue 1.

Seed, H, Idriss, I.(1971). Simplified proceedings for evaluating soil liquefaction potential . *Journal of Soil Mechanics*. Foundation Division, pp1249 – 1273.

Sladen, J., D'Hollander, R., Krahn, J. (1985). The liquefaction of sands, a collapse surface approach. *Geotech Journal*. Ca, pp 564-578

Torres, R., Paladio, M., Punong bayan, R., Alonzo, R. (2001). Mapping of areas affected by liquefaction during the 16 July 1990 earthquake. *The July 16 Luzon Earthquake - A Technical Monograph* [Online]. pp. 43-46. Available: [http://www.phivolcs.dost.gov.ph/html/update\\_SOEPD/1990LuzonEQ\\_Monograph/pp043/pp043\\_046.html](http://www.phivolcs.dost.gov.ph/html/update_SOEPD/1990LuzonEQ_Monograph/pp043/pp043_046.html)

Tosun, H., Seyrek, E., Orhan, A., Savas, H., Turkoz, M. (2011). Soil liquefaction potential in Eskisehir, N.W Turkey. *National Hazards and Earth System Sciences*.

ZillurRahman, M., Siddiqua, S., Kamal, M. (2015). Liquefaction hazard mapping by liquefaction potential index for Dhaka city, Bangladesh. *Engineering Geology*, pp 137 – 147



# Evaluation of School-Based Feeding Program : Towards the Development of the TRAC Feeding Program Model

Alma M. Corpuz  
College of Science  
Tarlac State University

Cynthia, G. Quiambao  
College of Education  
Tarlac State University

**Abstract:** During the start of SY 2017-2018, 40 pupils were found to be wasted and severely wasted in a public elementary school in Tarlac City, Central Luzon, Philippines. Upon request of the school head, a double meal feeding program was conducted for 90 days. The study then evaluated the outcome of the feeding program in terms of its effect to the pupils' nutritional status, academic performance and their attitude in school. Participants of the study were 40 pupils under the feeding program, eight teachers and a school head and six parents who assisted the feeding program. Findings revealed that the feeding program was able to improve the nutritional status of 83% of the pupils and had improved pupils' attitude towards classroom tasks, teachers, classmates, self-esteem and confidence. However, pupils' academic performance before and after the feeding program was not significantly different. Moreover, teachers and parents claimed that active participation of various school stakeholders, including the presence of external supporters during the actual feeding days were vital factors that contributed to the success of the program. But along the process, the teachers and parents who actively participated had encountered some problems which included pupils who did not report to school regularly and therefore had not completed the 90 days feeding program; some pupils who lacked appetite; and some demanding parents. The study recommends drafting of policy when conducting feeding program; livelihood training skills for parents to earn additional income so that they are able to provide nutritious meals at home; and training on mothers in preparing low cost nutritious meals. Based on the findings of the study, A *trAC School-based Feeding Program* model was developed.

**Keywords:** Feeding program, wasted, severely wasted, community extension, proper nutrition, academic performance, body mass index, feeding program model

## 1. Introduction

Community extension must address the pressing needs of the people and lay the grounds to usher them towards achieving a level of development. It has to be borne out of a needs assessment survey so that it becomes a viable support in helping people reach meaningful and productive life. This is the essence of the fourth pillar of the United Nations, which is "attainment of development." The aim of this pillar is to "promote social progress and better standard of life." The components of development are long and health life; education; decent standard living; and freedom to participate in the life of one's community (United Nations, 2018).

The fourth pillar of the United Nations are captured in almost all programs of the governments across the UN member nations. For example, the Department of Science and Technology continues to carry out research to improve the quality of life; the Department of Health tries hard to manage the health of people so that they are able to function the best they could as part of the society; the Department of Social Welfare and Development is tasked to provide support for the underprivileged members of the community (USA.gov, 2018; Intellectual Property Office of the Philippines, 2018).

No less than the educational institutions are directed to actively participate in attaining holistic development of the learners. Schools are expected to equip the learners with knowledge, skills and proper attitude that will enable them to cope with the complexities of life. Likewise, schools are challenged to integrate with the community to achieve harmony in providing the kind of education learners need for productivity.

After all, the popular adage is a resounding truth “Education is the key to success” and educational institutions must work effectively to make this adage work for all those who study hard to attain a level of development (Jones, 2011; McCartney, 2015; World Data on Education, 2007; Official Gazette of the Philippines, 2013).

Development does not only pertain to accumulation of material resources but also, of possessing good health and to sustaining it. The World Health Organization (2018) stated that better health makes an important contribution to economic progress since healthy populations live longer and are more productive.

Health must then be a priority goal of the nation. Government agencies, hand-in-hand with private institutions, must endeavor to address the health needs of the communities. If the human resource is healthy, achieving development is most likely possible. This principle also applies in education.

Students must be healthy to have a better academic achievement (Chen and Lee, 2016; [Baldwin, Towler, Oliver, and Datta, 2017](#)). Likewise, good health improves learning potentials. Students must be in good health for them to take full opportunities of what school can provide ([Al-Shehri, 2002](#)).

It is along this principle that Tarlac State University College-based extension program included health interventions to address health problems of the community. One of the adopted communities of TSU is Trinidad Elementary School (TES), a public school situated in one of the poorest barangays in Tarlac City. Based on needs assessment, 40 pupils were categorized to be wasted and severely wasted. They needed to be enrolled in a feeding program in order to gain normal nutrition.

The Department of Education allotted budget for feeding program in schools where there are undernourished pupils. This is prescribed in Department Order No. 39, series of 2017. According to this DO, the DepED, through the Bureau of Learners Support Services -School Health Division (BLSSHD), shall implement a school-based feeding program (SBFP) to address undernourishment of school children in public schools. This aims to improve the nutrition of wasted and severely wasted pupils by at least 70% at the end of 120 days. Secondly, it aims to increase attendance of the pupils by at least 85% to 100% and improve the pupils’ health, nutrition, values and behavior (DepED 2017). However, the budget is not adequate to sustain the feeding program since according to the city health office, feeding must last from 90 to 120 days to ensure that pupils gain normal nutrition.

After tapping linkages and networks, a feeding program was launched in October 2017. The school head of TES handed the list of qualified pupils for the feeding program. The feeding program was mostly funded by a non-government organization, Pioneer Project REACH, Inc, chaired by Dr. Alma M. Corpuz. Other supporters were Student Teachers’ Organization of TSU College of Education batch 2018, chaired by Dr. Cynthia G. Quiambao, PI OMICRON International Organization headed by the TSU Chapter President Jomar Manuel, Philippine Association of Medical Technologists, Tarlac Chapter, headed by the president, Narcisa Agustin, and students of the Master of Arts in Education-Physical Science major, AY 2017-2018.

This study is then conducted in order to evaluate the outcomes of the feeding program and the inspirations that it brought to the extension providers, supporters and the recipients. Findings led to the development of model in conducting feeding programs in the community.

## **2. Objectives of the study**

The general objective of the study is to evaluate the implementation of the feeding program in Trinidad Elementary School, SY 2017 -2018. Moreover, the following are the specific objectives of the study:

1. Describe the implementation of the feeding program;
2. Evaluate the outcome of the feeding program in terms of improvement in the pupils;

- 2.1. Nutritional status;
  - 2.2. Academic performance;
  - 2.3. Attendance; and
  - 2.4. Behavior.
3. Identify the best practices in the implementation of the feeding program:
  4. Identify the problems encountered in the implementation of the feeding program; and
  5. Develop a feeding program model based on the findings of the study.

### **3. Methodology**

#### **3.1. Research Design**

The study employed the descriptive -evaluative design in gathering and analyzing the data gathered to provide answers to the research questions.

#### **3.2. Research Locale**

The feeding program was carried out in Trinidad Elementary School. This is categorized as a small school by the DepED since it only has 320 pupils in SY 2017-2018.

#### **3.3. Population and Sampling**

The data were gathered from 40 pupils who were selected through purposive sampling since these were only the ones included in the feeding program; six parents who assisted in the feeding program; 8 teachers, including the principal, who were selected via complete enumeration technique.

#### **3.4. Instrument and Data Gathering Procedure**

##### **3.4.1. Measurement of Body Mass Index (BMI)**

To determine the improvement in the nutritional status of the pupils, the health leader, assisted by two teachers, measured their BMI before and after the feeding program.

##### **3.4.2. Interview**

To gather data on the manner by which the feeding program was implemented, the health leader and the school head was interviewed using a semi-structured interview guide.

##### **3.4.3 Questionnaire**

To identify the problems in the implementation of the feeding program, a questionnaire was developed and distributed to the teachers and parents who assisted in the feeding program.

##### **3.4.4. Documentary Analysis**

To determine the effect of the feeding program to the academic performance of the pupils, records were obtained from their advisers. On the other hand, to determine improvement in behavior of the pupils, eight teachers were given evaluation checklists.

Research Ethics. To ensure that the rights of the participants are protected, parents' consents were obtained, including the permission or assent from the pupils, in the conduct of the study. Their permission was also secured to show some photos during the feeding program in this research.

##### **3.4.5 Statistical Treatment**

Simple descriptive statistics (frequency and percentage) and inferential statistics (t-test) were used in this study to analyze data.

### **4. Results and Discussion**

#### **4.1. Implementation of the feeding program**

A Memorandum of Agreement was forged between TSU College of Education and Trinidad Elementary, including the supporting organizations, in October 2017 after a community needs assessment survey was conducted. Based on the needs assessment survey, feeding program was deemed necessary because some pupils were undernourished. Other health interventions were also implemented such as health teachings and wound cleaning, alongside the feeding program.



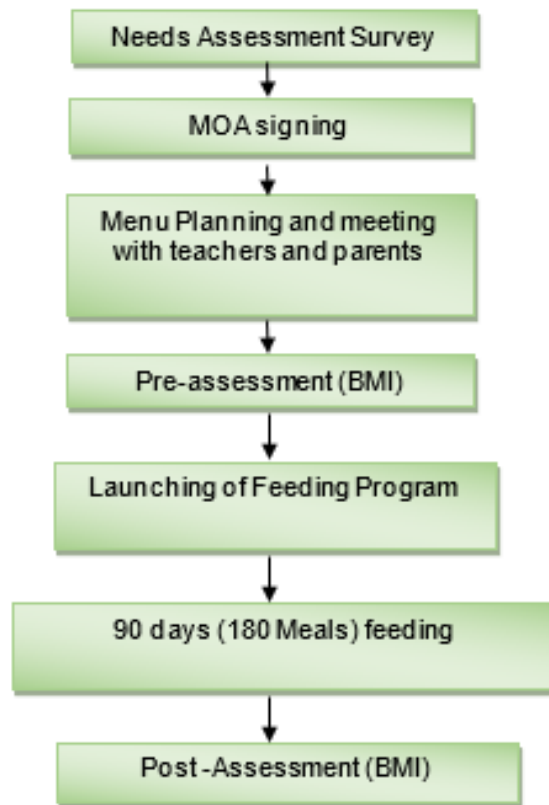

**Figure 1.** Flow chart of the Feeding Program

Figure 1 presents the flow chart of how the feeding program was conducted. Based on a needs survey, it was found that 40 pupils were either wasted or severely wasted. The school head of TES, Dr. Julius Gamis to prioritize feeding program in order address the nutritional needs of the pupils immediately. So, after MOA signing, a meeting to plan for the feeding program took place.



**Figure 2.** MOA Signing

Menus were based on the suggested meal plans from the DepED. The school head assigned the school health leader as the coordinator of the feeding program, with the assistance of two teachers, and his supervision. Parents were also asked to help, including the school canteen operator.

Before starting the feeding program, the BMI of the pupils were taken. After getting the BMIs of the pupils, feeding proceeded. Pupils had double meals- breakfast and lunch. Aside from the food, they were also given multivitamins daily and milk or chocolate. This ran for 90 days (180 meals). Ideally, according to the city health and DepED, feeding should run from 90 to 120 days to see improvement in the nutrition of the pupils.

Every day, the health leader and some parents went to the market to buy the needs to prepare for breakfast and lunch. There was a total of fourteen cavans of rice supplied to them for the entire feeding program. These were provided by the Pioneer Project REACH, Inc. (PPRI). Gas and drinking water were provided by the STO. Funds to purchase food materials were provided by PPRI, PI OMI-CRON International Alumni Assoc.,Tarlac Chapter, PAMET, Tarlac Chapter and MAED Physical Science Students.



**Figure 3.** Pre-Assessment (BMI)

Volunteer parents were in charged also of cooking, serving and cleaning the room where the feeding program was conducted. Parents, teachers and pupils took turns in giving milk and vitamins.



**Figure 4.** Milk and Vitamin



**Figure 5.** Breakfast meals of the Pupils

Breakfast is usually served in the classroom near the canteen where the meals are prepared 7:30 to 8:00 A.M. Before eating, pupils take turns in praying. The school head took time to share about saying "thank you" to the persons who supported the feeding program and to the Lord for the daily provisions. Usually breakfast consisted of soup, arrozcaldo, boiled bananas, boiled eggs, rice cakes, and milk or chocolate. Vitamins were also given after breakfast.

At around 11: 30 A.M. pupils proceeded to the room again for their lunch. The usual meals served during lunch time were pork or chicken adobo, pinakbet, sinigang, tinola, chop suey, fried chicken, mixed vegetables, fried fish, and La Paz bachoy. Pupils enjoyed the food served by their teachers and parents.

It should also be noted that before eating, pupils had to wash their hands in the pantry. The health leader usually inspected their nails before giving them food. Additionally, parents who prepared the food were also asked to wash their hands and use hairdressers to avoid introduction of contaminants.



**Figure 6.** Random Photos During Feeding Sessions

After 90 days, post-assessment was conducted. The health leader measured the BMIs of the pupils. The BMIs in pre-assessment were compared to the BMIs after feeding or the post-assessment. Results are discussed in the preceding tables.

A closing program was conducted after 90 days. The objective of the program was to give the pupils rice, vitamins and milk so that parents can continue feeding their children at home.



**Figure 7.** Take Home Rice, Milk and Vitamins



**Figure 8.** (A) Pupils Marching towards the Stage for the closing program; (B) Prayer before Opening of the Program; (C) PPRI Supporters were Recognized During the Closing Program; and (D) Figure 11. The Pi Omicron International Alumni Association, Tarlac Chapter, PAMET, Tarlac Chapter and the TSU Officials were given certificate of recognition for the Feeding Program.

Parents were more than glad and very appreciative of the closing program. They expressed their gratitude for the unselfish support provided by TSU-COED, PPRI, Pi Omicron International Alumni Organization, PAMET and STO.

Parent 1: *Labis na pasasalamat ang aming nais ibigay sa mga sumuporta sa aming mga anak. Hulog kayo ng Diyos.* (We are very much thankful for the support you gave to our children. You are God sent.)

This is what a mother expressed when they were given a chance to give their messages to the supporters.

#### 4.2. Outcomes of the Feeding Program

The nutritional status of the pupils was determined before and after the feeding program. Figure 7 shows the result.

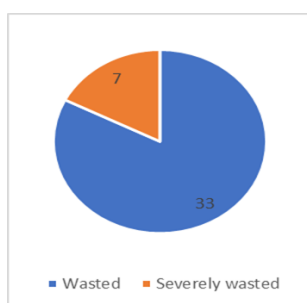

**Figure 9.** Nutritional Status Before Feeding

Before the feeding program, 7 or 18% out of 40 pupils were severely wasted while 33 or 82% were wasted based on the computations of the pupils' BMIs. The BMI is a measure of body fat based on height and weight and classifies the nutritional status of the pupils into obese, overweight, normal, wasted and severely wasted. DepED Memo. No. 241 series of 2010 is a guideline for public school teachers in determining the nutritional status of the pupils (DepED, 2010).

After the 50 days double feeding program (two meals), the nutritional status of the pupils was again measured.

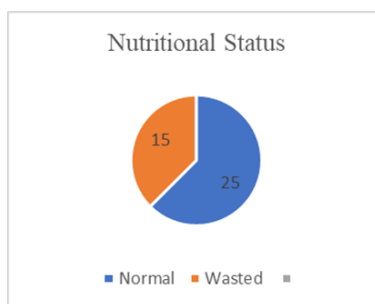

**Figure 10.** Nutritional Status After 50 Feeding Days

The health leader also measured their BMIs after the 90 days feeding program.

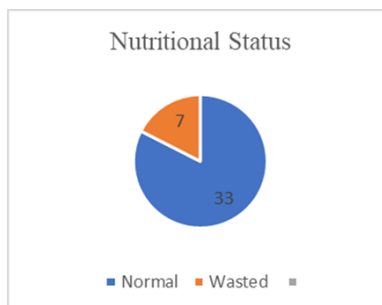

**Figure 11.** Nutritional Status After 90 Feedings Days

After 90 days double feeding, the number of pupils who gained normal nutrition was 33 and 7 failed to gain normal nutrition. These were pupils were severely wasted before the start of the feeding program. The health leader attributes this to non-regular attendance of the pupils in the feeding program. Some lacked appetite when eating despite the vitamins they are taking. Pupils who failed to gain normal nutritional status will resume feeding by June 2018.

T-test was used to compare the BMIs of the pupils before and after 90 days feeding program.

**Table 1.** T-test Result for the BMI results Before and After Feeding

Indicator	Mean of BMI	T--test	P value	Decision and Interpretation
Before Feeding	12.52	11.54	<0.00001	Reject Ho
After Feeding	14.93			Significant

\*0.05 level of significance

As shown in Table 1, the BMI of the pupils before and after the feeding program was significantly different as attested by a t -test value of 11.54 and a p value <0.05. The result of the study is consistent with the findings of Adamba (2017), Dei (2014) and Tabunda, Alber and Agdeppa (2016) that the nutritional status of the students who were subjected to school-based feeding program.

On the academic performance of the pupils, the grades before (1<sup>st</sup> and 2<sup>nd</sup> Quarters), during (3<sup>rd</sup> Quarter) and after the feeding program (4<sup>th</sup> Quarter) were compared. Grades of the pupils were obtained from the respective advisers.

**Table 2.** Pupils' Academic Performance in four quarters

Grade Bracket	1 <sup>st</sup> Quarter	2 <sup>nd</sup> Quarter	3 <sup>rd</sup> Quarter	4 <sup>th</sup> Quarter
90 and above	2	2	2	3
85-89	6	11	10	11
80-84	11	9	11	10
75-79	14	13	13	12
Below 75	3	1	0	0
Total	36	36	36	36
Mean Grade	81	82	82	83

\*four kindergarten pupils were not included as their grades are adjectival

As can be seen in Table 2, three pupils out of forty incurred failing grades in the first quarter, with only a pupil failed in the second quarter. In the third and fourth quarters, all pupils already had passing grades. However, it is clear that in all quarters, pupils whose grades fell on the 75-79 % dominated the class. Only about 3 or 8% got above 90%.

The mean grades per quarter has not also dramatically improved. From the mean grade of 81 in the first quarter, this only increased to 82 in the second and third quarters and 83 in the fourth quarter. ANOVA was used to determine if the grades in the 1<sup>st</sup> to 4<sup>th</sup> Quarters differed significantly. Data are shown in Table 3.

**Table 3.** Comparison of the Grades Obtained in the 1<sup>st</sup> to 4<sup>th</sup> Quarters (Analysis of Variance)

Source	SS	Df	MF	
Between Treatments	72.46	3	24.15	F=0.945
Within Treatments	3474.51	136	25.55	p value =0.42
Total	3536.91	139		

\*0.05 level of significance

ANOVA computation revealed an F value of 0.945 and a p value >0.05. These values are not enough to reject the null hypothesis. This means that pupils' grades in the 1<sup>st</sup> to the 4<sup>th</sup> Quarter did not differ significantly.

The findings contradict the result of the study conducted by Chakraborty and Jayamaran (2016)- that midday meals in Indian school had significantly improved the test scores of the pupils but consistent with the findings of [Adroque and Orlicki \(2013\)](#)-that in feeding program had not caused significant improvement in the school performance of the pupils.

As to the outcome of the feeding program to the behavior of the pupils. Table 4 shows the data. Teachers were the ones tapped to evaluate the behavior of the pupils before and after the feeding program.

**Table 4.** Attitude of Pupils Before and 50 Days After the Feeding Program

Attitude	Before Mean VD		50 Days After Mean VD	
	Mean	Grade	Mean	Grade
<b>Towards Classroom Tasks</b>				
Pupil is active in participating in class discussions.	2.51	G	4.25	VG
Pupil volunteers to read passages when teacher asks for volunteer readers.	2.61	G	4.25	VG
Pupil is glad to help other classmates cope with class activities.	3.28	G	4.29	VG
Pupil has a determination to complete classroom tasks within a specified time.	2.79	G	4.25	VG
Pupil willingly follows the rules/instructions/ directions set by teachers for class activity.	2.76	G	4.47	VG
<b>Grand Mean</b>	2.79	G	4.30	VG
<b>Towards Teachers</b>				
Pupil is respectful towards his or her teachers.	3.21	G	4.44	G
Pupil assists the teacher in preparing the classroom to start lessons or in fixing it when classes are done.	3.48	G	4.44	G
Pupil is enthusiastic in greeting the teacher in the morning.	3.55	VG	4.38	G
Pupil expresses his or her appreciation to the teachers.	3.51	V G	4.45	G
Pupil regards his/her teachers as her second parent.	3.15	G	4.46	G
<b>Grand Mean</b>	3.38	G	4.43	VG
<b>Towards Classmates</b>				
Pupil is friendly with his or her classmates.	2.89	G	4.22	G
Pupil acts as arbiter or neutralizer when there are fights in class.	2.81	G	4.27	G
Pupil helps his or classmates who needs some assistance.	2.84	G	4.28	G
Pupil leads unity and harmony among his or her classmates	2.71	G	4.25	G
Pupil does not start fights with his or her classmates	2.82	G	4.47	G
<b>Grand Mean</b>	2.81	G	4.30	VG
<b>Self-Esteem and confidence</b>				
Pupil believes in his abilities.	2.58	G	4.36	G
Pupil is confident in relating with his or her classmates and teachers.	2.57	G	4.31	G
Pupil is assertive.	2.55	G	4.44	G
Pupil feels he is important in class-that he has a unique role in class.	2.60	G	4.48	G
Pupil is bold in assuming his class responsibilities	2.61	G	4.51	VG
<b>Grand Mean</b>	2.58	G	4.42	VG
T-test Value = 19.52	P value= 0.00001		Level of significance =0.05	

Based on Table 4, data show that pupils' behavior towards their classroom tasks before the feeding program was generally good as attested by a grand mean of 2.79 then it improved to 4.30, very good after 50 days of feeding program. Teachers observed the pupils to have improved in their attitude towards their homework and their class participation. Teachers noticed that pupils became more involved in classroom tasks.

On the attitude of the pupils towards their teachers, the grand mean generated was 3.38 before the feeding program and improved to 4.43 after 50 days of feeding program. The ratings are higher in attitude towards their teachers than their attitude towards their classroom tasks. Teachers felt that because pupils were given attention during the feeding program, they tried to compensate or return back the gesture to them.

As to the pupils' attitude towards their classmates, the grand mean was 2.81 before the feeding program and 4.30 after 50 days of feeding. Teachers observed that pupils were happier and more excited to be with their classmates. They were always looking forward to another day in school.

In terms of their self-esteem and confidence, the grand mean computed before the feeding program was 2.58, good and improved to 4.42, very good. Teachers claimed that pupils had improved in dealing with their classmates and teachers. They became more assertive and positive in class. They felt important because they were given attention by the extension providers, teachers, parents and visitors.

The p value obtained for the ratings before and 50 days after the feeding program was  $>0.05$ , hence there is a significant difference between the attitude of the pupils before and after 50 days of being fed in school.

### 4.3. Best Practices in the Feeding Program

The school head, health leader, teachers and parents were asked about what they thought were the factors that contributed to the general success of the feeding program implementation. Data are shown in Table 5.

As shown in the table, the feeding program was generally successful because of the active leadership of the school head and good coordination of the school health leader. Parents were tapped to cook daily meals and clean the feeding area. External supporters (PPRI, COED-STO, TSU COED Extension chairperson, PAMET, Pi Omicron International Alumni Association and MAED Physical Science students) were visible during the feeding program and barangay leaders were present (they provided transport for the pupils when they were invited to a birthday party of one of the supporter

**Table 5.** Best Practices in the Feeding Program (N=15)

Best Practices	Frequency	Rank
School head is actively involved and fully supportive of the feeding program	15	2
Health leader is very responsible in coordinating the feeding program	15	2
Parents cooked and prepared the meals of the pupils.	15	2
External supporters (linkage and network) are visible in the feeding program	13	4
Partner school monitors the feeding program from time to time.	12	5
Barangay leaders are present in programs and provided support	10	6

For a feeding program to be successful, school stakeholders must actively participate. School heads must seriously integrate feeding program in their institutional priorities and find ways for funding. The role of the partner supporters is not just to provide the funds but to visit and monitor the progress of the program. The more visible the external supporters are, the more motivated the school, parents and pupils to do their responsibilities in the program. School and external supporters must communicate openly. They have to discuss the support needed and problems that occur during the program implementation. In this way, both partners come to solutions and the feeding program continues smoothly.

#### 4.4. Problems Encountered in the Feeding Program

Teachers and parents who assisted in the feeding program had encountered problems. These are shown in Table 6

Table 6. Problems in the Feeding Program (N=15)

Problems	Frequency	Rank
Pupils who were not regular in attending the feeding program because of absence in school.	15	1
Parents who demanded so much from the feeding program.	10	2
Pupils had to be fed by batches since the classroom where they used to conduct feeding underwent repair.	8	3
Some pupils who lacked appetite	7	4

According to the teachers and parents who assisted the feeding program, some pupils did not report to school regularly so they did not complete the feeding program. In addition, there were some parents who were demanding. They wanted more food ration. Likewise, some pupils lacked appetite in the morning despite the multivitamins given to them. Moreover, the feeding venue had to be repaired and there was no available room to house all pupils. They had to feed the pupils in batches.

#### 4.5. Proposed Model of a Feeding Program

Findings of the study revealed a generally successful feeding program. A model of a feeding program is thus developed.

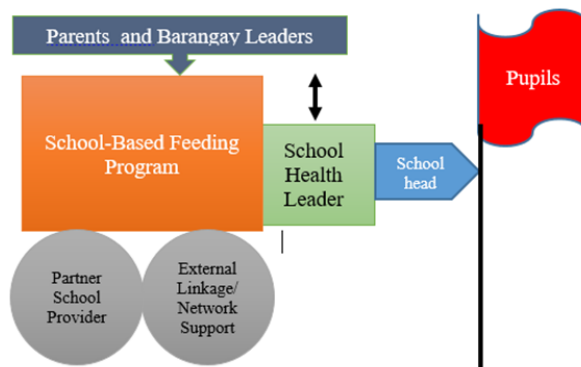

Figure 12. Proposed trAC Model for School-Based Feeding Program

Figure 15 shows a proposed model for a school-based feeding program. The figure looks literally like a truck. The school head is the driver supported by the health leader. Both actors are in-charge of maneuvering the feeding program. The two big wheels are the school extension provider and the external linkage /network whose role is to provide the material and financial support. The researchers coined the model as trAC which stands for *treat, reach, assist* and *care*. School stakeholders and external partners must reach out to provide the necessary treatment to the pupils (through feeding) in order to alleviate their nutritional status. Pupils need assistance and care until they reach normal nutrition.

Moreover, for a school-based feeding program to be successful, school heads must integrate feeding in the school programs. No matter how busy school heads are, they have to take full control of the feeding program. They have to work closely with the school health leaders-give clear and specific instructions on how they have to carry out the feeding program. Health leaders are important support to the school heads in the feeding program. They make sure that daily meals are prepared well, take BMIs from time to time to monitor improvement in their nutritional status, report to the school heads the progress of the feeding program. Likewise, they are responsible for coordinating with parents and barangay leaders to help them in the implementation of the feeding program. Parents are needed to help in preparing the meals, serving and cleaning the feeding area on a daily basis. Health leaders must focus their attention to the daily meals and what things to buy for the next day. They have to go to school early to work with parents in the food preparation.



Another important part of the vehicle are the two big wheels that propel the feeding program to its destination. Like the driver, the wheels are vital in catapulting the feeding program to reach its goal of improving the nutrition of the undernourished pupils. The school extension providers need to work-hand-in-hand with the external supporters or linkages to ensure that funds are provided on time. They also need to visit the feeding area from time to time to motivate the school beneficiaries to do their job efficiently.

Parents and barangay leaders also need to actively support the feeding program. They have to assist the school in preparing the daily meals and providing other needed materials.

If all the parts of the truck are functioning well, the objectives of the feeding program will be achieved. Like what is seen in the model, school-based feeding program has reached its destination.

## 5. Conclusions

1. The feeding program in TES consisted of breakfast and full lunch meal which ran for 90 days. Pupils had daily intake of multivitamins, and milk or chocolate drink. Parents, teachers and the extensionists, together with the supporters worked hand-in-hand in making the program successful.
2. Most pupils had gained normal nutrition after the feeding program. Although few were still wasted because of irregular attendance and lack of appetite to eat especially in the morning. Attitude of pupils before and 50 days after improved. Grades of pupils, however, had not improved after the feeding program.
3. Best practices during the feeding program was the active leadership of the school head and the good coordination of the health leader. The extension providers were also fully supportive and visible during the program. The external supporters- the network and linkages were also directly involved in the feeding program.
4. The problems encountered in the implementation of the program were irregular attendance of some pupils in the feeding program; parents who were demanding; feeding room had undergone repair; and pupils who lacked appetite in the morning.

## 6. RECOMMENDATIONS

1. Policies to ensure complete attendance in feeding must be crafted. For example, if a pupil is unable to go to school, parents should get the food for their children in school.
2. Nutritional status of the pupils should be measured during the opening of school for 2018. This will provide information if parents were able to sustain feeding during the school break.
3. Another study may be conducted to assess the capacity of the parents and their knowledge on how prepare nutritious meals using low budget so that they continue feeding their children with nutritious food at home.
4. School heads may look for supporters who can provide livelihood training skills to parents who cannot provide nutritious meals for their children.
5. Another study may be conducted to look into the factors affecting the academic performance of the pupils since findings of the study showed that improvement of nutrition had not caused improvement in their academic performance.
6. The trAC Model may be adopted by public schools in implementing their school-based feeding program.

## References:

- Adamba, C. (2017). Evaluation of alternative school feeding models on children's educational outcomes: preliminary findings from a cluster randomised control trial. Accessed June 8, 2018 from <https://www.poverty-action.org>. Bida.
- Adroque, C. and Orlicki, M. (2013). Do in-school feeding programs have an impact on academic performance and dropouts? the case of public schools in Argentina. Accessed June 8, 2018 from <https://epaa.asu.edu/ojs/article/view/1162>
- Al-Shehri, S. (2002). Healthy Students-Healthy Nation. Retrieved June 8, 2018 from <https://www.ncbi.nlm.nih.gov/pmc/articles/PM3430170/>
- Baldwin, D., Towler, K., Oliver, M., and Datta, S. (2017). An examination of college student wellness: A research and liberal arts perspective. Retrieved June 8, 2018 from <http://journ.als.sagepub.com/doi/full/10.1177/2055102917719563>
- Buttenheim, A., Alderman, H., and Friedman, J. (2011). Impact Evaluation of Feeding Programs in Lao PDR. Accessed June 7, 2018 from <https://openknowledge.worldbank.org/handle/1986/13337>
- Chakraborty, T. and Jayamaran, R. (2016). School Feeding and Learning Achievement: Evidence from India's Midday Meal Program, Accessed June 9, 2018 from <http://ftp.iza.org/dp10086.pdf>
- Chen, F. and Lee, A. (2016). Health-promoting educational settings in Taiwan: development and evaluation of the Health-Promoting School Accreditation System. Retrieved June 8, 2018 from <http://journals.sagepub.com/doi/full/10.1177/177975916638286>
- Dei, A. (2014). An Evaluation of the School Feeding Programme : A Case Study of Magog Primary School. Accessed June 8, 2018 from <http://uir.unisa.ac.za/>
- Department of Education (2017). DO 39, s. 2017 – Operational Guidelines on the Implementation of School-Based Feeding Program for School Years 2017-2022. Retrieved June 8, 2018 from <http://www.deped.gov.ph/orders/do-39-s-2017>
- Department of Education (2011). DO 43, s. 2011M Strengthening the School Health and Nutrition Programs For the Achievement of the Education for All (EFA) and Millennium Development Goals (MDGs). Accessed June 9, 2018 from <http://www.deped.gov.ph/orders/do-43-s-2011>
- DepED (2010). DepED Memo. No. 241, series of 2010. Accessed June 8, 2018 [http://www.deped.gov.ph/sites/default/files/memo/2010/DM\\_s2010\\_241.pdf](http://www.deped.gov.ph/sites/default/files/memo/2010/DM_s2010_241.pdf)
- Global Alliance for Improved Nutrition (2012). Facts About Malnutrition. Retrieved June 8, 2018 from <https://www.gainhealth.org/knowledge-centre/fast-facts-malnutrition/>
- Intellectual Property of the Philippines (2018). Government Agencies. Retrieved June 8, 2018 from <https://www.ipophil.gov.ph/links/government-agencies>
- Jones, A. (2011). Knowledge and Skills and Disposition for Diversity. Retrieved June 8, 2018 from <https://files.eric.ed.gov/fulltext/ED522824.pdf>
- McCartney, D. (2015). The Role of Education in National Development. Retrieved June 7, 2018 from <https://www.linkedin.com/pu>
- National Center for Chronic Disease Prevention and Health Promotion (2014). Health and Academic Achievement. Accessed June 7, 2018 from <https://www.cdc.gov/>
- Official Gazette of the Philippines (2013). Implementing Rules and Regulations of the Enhanced Basic Education Act of 2013. Retrieved June 7, 2018 from <http://www.officialgazette.gov.ph/>

- Olivera, M. (2012). The Link Between Nutrition and Academic Performance. Retrieved June 8, 2018 from <http://nbclatino.com/2012/08/30/the-link-between-nutrition-and-academic-performance/>
- Ross, A. (2010). Nutrition and Its Effects on Academic Performance. How Can Our Schools Improve? Retrieved March 8, 2018 from <https://www.nmu.edu>
- Shaw, A., Gomes, P., Polotskaia, A., and Johnkowska, A. (2015). The relationship between student health and academic performance: Implications for school psychologists. Retrieved June 9, 2018 from *School Psychology International* 2015, Vol. 36(2) 115–134. DOI:10.1177/0143034314565425spi.sagepub.com
- United Nations (2018). The 4 Pillars of United Nations. Retrieved June 8, 2018 from <https://outreach.un.org>
- United Nations Children Fund (2018). Health and Nutrition. Accessed June 8, 2018 from <https://www.unicef.org/>.
- USA.gov. (2018). A-Z Index of U.S. Government Departments and Agencies. Retrieved June 8, 2018 from <https://www.usa.gov/federal-agencies/a>
- Tabunda, A., Albert, J. and Agdeppa, I. (2016). Results of an Impact Evaluation Study on DepED's School-Based Feeding Program. Accessed June 8, 2018 from <https://dirp3.pids.gov.ph>.
- United States Department of Agriculture (2018). USDA Nutrition Assistance Program Retrieved June 7, 2018 from <https://www.nal.usda.gov/fnic/usda-nutrition-assistance-programs>
- World Data on Education. (2007). Principles and General Objectives of Education. Retrieved June 6, 2018 from [http://www.ibe.unesco.org/sites/default/files/United\\_States\\_of\\_America.pdf](http://www.ibe.unesco.org/sites/default/files/United_States_of_America.pdf)
- World Health Organization (2018). Child Malnutrition. Retrieved June 8, 2018 from <http://www.who.int/gho/child-malnutrition/en/>
- World Health Organization (2018). Health and Development. Retrieved June 7, 2018 from <http://www.who.int/hdp/en/>
- World Health Organization (2018). Reducing stunting in children: equity considerations for achieving the global targets 2025. Retrieved June 8, 2018 from <http://www.who.int>
- World Health Organization (2016). What is Malnutrition? Retrieved June 8, 2018 from <http://www.who.int/features/qa/malnutrition/en/>

# Ang Programang Filipino ng mga Pang-Estadong Unibersidad at Kolehiyo sa Rehiyon III: Batayang Pag-aaral tungo sa isang Akademikong Modelong Pangwika

Dexter L. Manzano  
College of Arts and Social Sciences  
Tarlac State University

**Abstrak:** Pangunahing layunin ng pag-aaral na ito na makabuo ng isang mungkahing akademikong modelong pangwika batay sa isinagawang pagsusuri sa kasalukuyang kalagayan ng programang Filipino sa labintatlong (13) pang-estadong unibersidad at kolehiyo sa Rehiyon III. Ang pag-aaral ay highly qualitative kung kaya't ang mga nakalap na datos ay dumaan sa isang masikha na pag-aaral, paghihimay sa bawat bahagi at pagsusuri sa kabuuang lawak at antas ng paglalarawan na siyang nagsilbing landas sa pagbuo ng isang mungkahing akademikong modelong pangwika. Natuklasan na walang pormal, malinaw at tiyak na patakarang pangwika na ipinapapatupad sa bawat pang-estadong unibersidad at kolehiyo sa Rehiyon III. Ang mungkahing modelong akademikong pangwika ay deskriptibo lamang at hindi preskriptibo. Mula rito, nabuo ang isang mekanismo upang magkaroon ng malinaw na patakarang pangwika sa apat na tunguhin at sa iba pang gawain ng mga pang-estadong unibersidad at kolehiyo sa Rehiyon III at maging sa mga gawaing ko-kurikular o ekstra-kurikular. Ang mga pangunahing yugto nito ay kinapapalooban ng pagpapalano, disenyo ng patakarang pangwika, konsultasyon at diseminasyon, implementasyon, at ebalwasyon. Gayunpaman, masasabing walang mga modelo at patakaran ang makapagbibigay tuldok sa patuloy na pag-aaral at pagsasakatuparan ng mga programang pangwika.

**Terminolohiya:** Pagpaplanong Pangwika, Patakarang Pangwika, Akademikong Modelong Pangwika, Programang Filipino, mga Gawaing Kurikular at Ko-kurikular

## I. Panimula

Ang kapangyarihan ng wika ay nagpapamalas ng kahandaan sa anumang pagpapaunlad nito upang lalo pang magamit ng may katatasan sa mga taong tumatangkilik nito. Kung gayon, marapat na bigyang pansin ang napapaloob na programang pangwika ng isang akademikong institusyon. Maraming salik ang nakakiling sa mga programang pangwika na kung minsan ay naisasawalang bahala lalo pa at ito ay wikang Filipino na sa tingin ng ilan, wikang mas mahina kumpara sa prestihiyosong wikang Ingles. Ang mas mayamang kaalaman at mas pursigidong pananaliksik, pag-aaral, at pakikipaglaban sa kung anong wikang mas nararapat mamayagpag sa bansang Pilipinas ay nagdudulot ng pagpapahalaga ng ilang mga Pilipino sa Ingles kaysa sa wikang pambansa. Subalit dapat iwaksi at ituon sa pag-aaral at pagpapalago ng pambansang wika ang walang hanggang pakikipaglaban sa disposisyong ito.

Sa layuning mailarawan at masuri ang kasalukuyang programang Filipino sa mga pang-estadong unibersidad at kolehiyo sa Rehiyon III, tinangka ng mananaliksik na mailarawan at masuri ito ayon sa mga kasalukuyang kaalaman sa programang pangwika (Rodgers, 2001; Bobbit, 1918). Sinikap nitong mailarawan at masuri ang kurikular at ko-kurikular na programa sa Filipino upang sa ganuon ay mabigyan ng masusing pag-aaral kung ito ba ay nagpapakita ng isang proseso, kalakaran o *trend* sa lahat ng pang-estadong unibersidad at kolehiyo ng Rehiyon III. Ang tunguhing ito ay magbibigay ng diwang aral sa kung saang antas nakatuon ang mga programang ito, paano nabubuo ang mga pang-institusyonal na pagpapalano at pagsasakatuparan, ang kahihinatnan ng programa sa mga mag-aaral, ang pagsusuri sa kung saan napapanatili at napapaunlad ang programang Filipino ng General Education, maging ang mga nasusumpungang mga suliranin ng mga guro at mag-aaral sa pagsasakatuparan ng programa sa mga pang-estadong unibersidad at kolehiyo ng Rehiyon III.

Ayon kay Constantino (2005) mahalaga ang paghihimay, pagsusuri, at pagtataya sa watak-watak at sabog-sabog na kaalamang may kinalaman sa wika batay sa praktis ng institusyon. Anumang pagbabagong dulot nito ay dapat tanggapin at tangkilikin. Nangangahulugan ito na pinag-iisipan o may tangkang suriin ang kabuluhan at pangangailangan ng dati na o ng narito na. Mahalaga ito lalo na sa larangan ng edukasyon, partikular sa kurikulum, dahil malaki ang epekto nito sa pangkalahatang kaunlaran hindi lang ng kaisipan kundi ng buong lipunan. Gayunpaman, ang anumang pagbabago lalo na sa isang demokratikong lipunan, gaya ng Pilipinas, ay laging nahaharap sa mga pagpuna at pagkilatis, konstruktibo man o hindi, lalo na kung nangangahulugan ito ng matagalang pagpapatupad at epekto.

Ang mga simulaing nabanggit ang siyang naghimok sa mananaliksik na tangkaing bigyang deskripsiyon ang kasalukuyang programang Filipino ng mga pang-estadong unibersidad at kolehiyo sa Rehiyon III. Ang mga kinalabasan ng pagsusuri sa mga impormasyong nakalap ay pinilit maging daluyan ng isang akademikong modelong pangwika na tutugon sa pangangailangan ng mga mag-aaral sa gitnang Luzon.

## 2. Paglalahad ng mga Layunin

Pangunahing layunin ng masusing pag-aaral na ito na makabuo ng isang mungkahing akademikong modelong pangwika para sa mga pang-estadong unibersidad at kolehiyo ng Rehiyon III batay sa isinagawang pagsusuri sa kasalukuyang kalagayan ng programang Filipino. Ang mga layunin na hinangad makamit ay ang mga sumusunod:

1. Mailarawan at masuri ang batayang programa sa Filipino batay sa kurikulum at mga gawaing koku-rikular;
2. Mailahad ang mga suliraning kinakaharap sa programa ng Filipino at mabigyan ng solusyon alinsunod sa mga pangangailangan ng mga guro at mga mag-aaral;
3. Matukoy ang mga saligan na dapat isaalang-alang sa pagbalangkas ng isang akademikong modelong pangwika batay sa isinagawang pagsusuri sa kasalukuyang programa sa Filipino; at
4. Makabuo ng isang mungkahing akademikong modelong pangwika na tutugon sa napapanahong pangangailangan ng mga mag-aaral ng pang-estadong unibersidad at kolehiyo sa Rehiyon III.

## 3. Pamamaraan

Ginamit ang deskriptibong pamamaraan ng pananaliksik sa pag-aaral na ito. Sapagkat ang pag-aaral ay *highly qualitative*, ang mga nakalap na datos ay dumaan sa isang masikhay na pag-aaral, paghihimay sa bawat bahagi at pagsusuri sa kabuuang lawak at antas ng paglalarawan na siyang nagsilbing landas sa pagbuo ng isang mungkahing akademikong modelong pangwika.

Labintatlong pang-estadong unibersidad at kolehiyo sa Rehiyon III ang mga naging kalahok sa pag-aaral na kinabibilangan ng Aurora State College of Technology (ASCOT), Central Luzon State University (CLSU), Nueva Ecija University of Science and Technology (NEUST), Tarlac State University (TSU), Tarlac College of Agriculture (TAC), Don Honorio Ventura Technological State University (DHVTSU), Pampanga Agricultural College (PAC), Philippine State College of Aeronautics (PhilSCA), Ramon Magsaysay Technological University (RMTU), Philippine Merchant Marine Academy (PMMA), Bataan Peninsula State University (BPSU), Bulacan State University (BulSU), at Bulacan Agricultural State College (BASC). Bawat unibersidad o kolehiyo ay may kinatawang limang guro sa Filipino maliban ang PhilSCA at PMMA na may tig-isang propesor sa Filipino lamang. Gaya ng pagpili sa mga guro, sa paraang pasumala rin nalikom ang limampung mag-aaral sa bawat institusyon.

Sa mahalagang kadahilanan, may mga ilang kalahok ang hindi nakapagbalik ng mga instrumento datapwa't hindi naman ito nakaapekto ng malaki sa kinalabasan ng pag-aaral. Samakatuwid, 57 na guro sa Filipino ang naging kasapi samantalang 645 naman ang kabuuang bilang ng mga mag-aaral na naging kalahok. Nagsagawa rin ng mga impormal na panayam ang manaliksik sa ilang mga administrador, guro, at mag-aaral ng mga pang-estadong unibersidad at kolehiyo. Wala nga lang partikular na bilang ang mga nabanggit na nakapanayam at naging madalian lamang ito sapagkat ito ay dumipende lamang sa mga taong nasumpungan noong mga panahong nagpapamudmod ng talatanungan na siyang naging basehan ng mas malalimang pag-aaral. Tatlong mahalagang instrumento at teknik ang ginamit sa pagkalap ng mga datos mula sa mga guro at mag-aaral ng mga pang-estadong unibersidad at kolehiyo sa Rehiyon III: (1) talatanungan, (2) panayam, at (3) obserbasyon.

#### 4. Resulta ng Pagaaral

Ang pagkakasunod-sunod ng talakayan sa bahaging ito ay batay na rin sa nabalangkas na layunin ng pananaliksik.

##### 4.1. Paglalarawan sa Batayang Programa sa Filipino ng mga Pang-estadong Unibersidad at Kolehiyo sa Rehiyon III

Lumabas sa pag-aaral na walang pormal, malinaw, at tiyak na patakarang pangwika ang mga pang-estadong unibersidad at kolehiyo sa Rehiyon III. Ito marahil ay dulot ng kawalan ng lokal na komite na siyang mangunguna sa pagsulong ng mga gawaing pangwika, magbalangkas ng tuntunin ng wika ayon sa gamit nito sa pagtuturo at pagkatuto. Isang nakapanlulumong katotohanan sa kasalukuyan subalit hindi kailanman mapagkakaila na ang pagkalito sa kung anong meron sa kasalukuyang programang pangkurikulum at gawaing ko-kurikular ay hindi masabi ng mga pinagtutuunan kung meron nga bang programang pangwika o wala. Ang isang programang pangwika ay nagan-gailangan ng mga tuntuning marapat sundin, mga gawaing konsistent o regular na naisasagawa, may komiteng tagapagsulong sa pagpapanatili at pagpapabuti nito, may mga gawaing nakadiseno sa isang taon, may malinaw na gawaing pang-kurikulum at ko-kurikular, may malinaw na diseminasyon sa programa, nalalapatan ng angkop na ebalwasyon, at higit sa lahat may malinaw na tunguhin na nalalaman ng lahat ng taong kasangkot sa akademikong komunidad.

##### 4.1.1. Kurikulum

Ang kurikulum ay tumutukoy sa isang malawakang konsepto tungkol sa lahat ng gawain ng mag-aaral ayon na rin sa layunin ng institusyon. Hindi lamang ito ayon sa kung ano ang natututunan ng mag-aaral, subalit kung paano nila ito natutunan, kung paano nakatutulong ang mga guro sa kanilang ganap na pagkatuto gamit ang mga angkop na kagamitang pampagtuturo, istilo, metodolohiya, pagtataya, at sa kung anong uri ng pasilidad mayroon ang unibersidad o kolehiyo (Rodgers, 1989). ). "Layunin ng tersiyaryong kurikulum na tulungan ang mag-aaral na makita ang tao bilang isang integral na nilalang na bahagi hindi lang ng kaniyang bansa kundi pati ng global na komunidad. Naglalayong umangkop at tumugon ang General Education Curriculum sa edukasyong Filipino sa mga hamon at kahingian ng bagong milenyum. Pag-unlad at pagbabago, kasabay ng pagpapanatili sa mga pamanang pagpapahalagang tutulong sa pagpapatatag ng kultura ng inaasahang matutugunan ng nasabing kurikulum" (Constantino, 2005).

Ayon sa pagsusuri, naging batayan ng mga pang-estadong unibersidad at kolehiyo ang ipinalabas na Memorandum Bilang 4, Serye ng 1997 tungkol sa *bilang ng yunit* sa mga kursong HUSOKOM (Humanities, Social Sciences, Communication) at di-HUSOKOM (siyentipiko at teknikal). Naging matapat ang mga administrador at kaguruan sa pagpatupad nito. Anim na yunit ang ipinatupad sa mga di-HUSOKOM na kurso samantalang siyam na yunit naman sa mga HUSOKOM na kurso. Sa Memorandum Bilang 11, Serye ng 1999 naman inilatag ang bilang ng yunit sa mga institusyong pangguro o Teacher Education Institution. Tingnan ang balangkas ng yunit sa Filipino sa mga pang-estadong unibersidad at kolehiyo:

**Talahanayan 1.** Balangkas ng Yunit sa Filipino

HUSOKOM	Di-HUSOKOM	TEI
9 Filipino	6 Filipino	6 Filipino
0 Panitikan	0 Literatura	3 Literatura

Ang pagkakaltas sa bilang ng yunit sa bawat disiplina ay isang hudyat ng pagpapasikip sa daluyan ng pagpapalaganap sa wikang Filipino. Kung bubusisihin at hihimayin ang ganitong tuntunin, isa itong limitasyon sa pagpapayabong ng kasanayan at kamalayang Pilipino. Totoo na ang wika ay nahahasa at natutunan sa likas na pakikipagtalastasan, subalit ang uri at antas ng katatasan sa akademikong konteksto ay kaiba sa nakagisnang uri ng wikang Filipinong likas na gamit sa pakikipagtalastasan. Dito lumalabas ang kahinaan ng programa, sapagkat ang simulain na nakatatak sa isipan ay nagdudulot ng higanteng suliranin sa mga kasanayang malimit masumpungang kahinaan – ang pagsulat sa teknikal na aspeto, katulad ng riserts, sulat, ulat o report at dagdag pa rito ang walang kamatayang isyu sa pag-uugali ng bawat indibidwal sa wikang Filipino.

**Talahanayan 2.** Batayang Asignatura sa Filipino

Kowd	Deskripsiyon
Filipino 1	Komunikasyong Pang- Akademiko
Filipino 2	Pagbasa at Pagsulat tungo sa Pananaliksik
Filipino 3	Retorika: Mabisang Pagpapahayag

Suriing mabuti kung anim na yunit lamang ang ipinapatupad ng mga pang-estadong unibersidad at kolehiyo, saan masusumpungan ang katatasan sa pagpapahayag at kung siyam na yunit naman, hindi rin mahahagilap ang panitikan ng mga Pilipino na kalimitang nagpapaalala sa nakagisnang kultura at pagpapahalaga. Tandaan na ang mga mag-aaral ng mga pang-estadong unibersidad at kolehiyo ay galing sa mga mahihirap o nagmula sa mga kasapi ng lipunang kulang sa pribilehiyong sosyal kaya malimit Filipino ang gamit sa pakikipagtalastasan sa iba't ibang minorityang grupo. Dagdag pa rito, madalang sa mga mag-aaral ang may katatasan sa Filipino gaya ng mga ilang mag-aaral sa BuSU, NEUST, CLSU, at DHVTSU sapagkat karamihan ito ang unang wika nila, subalit karamihan ay gumagamit ng Pampango at Iluko at ang ilan ay Zambal, Pangasinense, at Visayan. Masasabing madalang ang may unang wika nito kaya katulad ng Ingles, hindi ito ganuon kadali sa mga mag-aaral na Iluko, Kapampangan, Zambal, Pangasinense, at Visayan na siya ring dapat gawing batayan sa pagpaparami at pagtatalaga ng yunit sa Filipino.

Samantala, walang kongkreto at regular na panahon at basehan ng pagrerebisa ng mga silabus. Ang pagrerebisa ay nakadepende sa silabus na preskriptibo ng Komisyon sa Lalong Mataas na Edukasyon. At kung mangyari man, ang mga aklat ang nagsisilbing basehan ng pagsasaayos ng mga nilalalaman at organisasyon ng silabus.

Ang mga guro sa Filipino naman ay sadyang naging tradisyonal sa kanilang pagtuturo. Lektyur at pagtalakay ang naging kalakaran at ang ang silid-aralan ang naging pinakamahalagang pasilidad sa instruksiyon.

**4.1.2. Ko-kurikular**

Institusyonal at rehiyonal na mga ko-kurikular na gawain ang naipapamalas ng bawat pang-estadong institusyon sa Rehiyon III. Ang lahat ay nagdaraos ng Buwan ng Wika, ang ilan naman ay nagsasagawa ng pagsulat ng sanaysaysay, tula, at maikling kuwento at nakikilahok sa mga talumpati, dula, at sayawit. Naging tradisyon na ang mga ganitong patimpalak pati ang ilang partikular na gawain katulad ng *Pinoy Henyo sa Fil 100*, *Fliptop*, at *Patinikan sa Panitikan*.

Sa kasalukuyan, naipapamalas sa mga gawaing institusyonal ang pagpapahalaga ng mga administrador at guro sa wikang Filipino bilang wikang gamit sa pakikipagtalastasan at ang wikang Ingles bilang wika sa komunikasyong pasulat. Samantala, ang mga mag-aaral ay mas pinapaboran ang gamit ng wikang Filipino sa dalawang paraan, pasulat man o pasalita maliban sa ilang gawain tulad ng riserts, paggawa ng programa, pagsulat ng mga komunikasyon tulad ng ulat o report. Nangan-gahulugan lamang ito na sa perspektibong teknikal, mas pinapaboran ng nakakarami ang pagsulat sa Ingles sanhi ng mga dokumento o reperensiya na nakalimbag sa Ingles. Ang teknikal na pagsulat sa Filipino ay nangangailangan din ng isang masikhay at pormal na pagsasalang-wika na isa namang napakalawak na disiplina at nangangailangan ng sapat na kaalaman at kahusayan kaya isang mapanghamong trabaho nga naman ang magsulat ng riserts sa Filipino. Marapat ding isaalang-alang kung gayon ang karunungan at kakahayan sa pagsasalin upang tuluyang magamit ang wikang Filipino sa komunikasyon, pasalita man o pasulat.

#### 4.1.3 Disenyo ng Pagpaplanong Pangwika sa Akademikong Konteksto

Isang *linear* na proseso ang ipinapamalas ng pigura sa pagpaplanong pangwika kontekstong Akademiko. Ang Komisyon sa Lalong Mataas na Edukasyon ang nagsisilbing tagapagsulong ng mga asignaturang isinasama sa kurikulum ng Filipino. Anumang kinalabasan ng pagpaplanong ay ipinapatupad ng mga administrador at ang mga guro ang nagsisilbing instrumento sa pagpapatupad ng mga ito. Ang mga mag-aaral naman ang tagatanggap ng anumang programa kaya sa kanila nalalaman ang tunay na kaganapan ng kurikulum at ko-kurikular na

gawain.

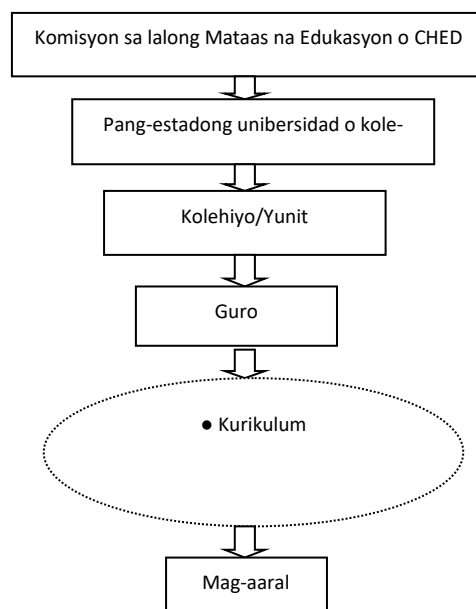

**Pigura. 1.** Deskriptibong Proseso ng Pagpaplanong Pangwika sa Akademikong Konteksto

Ang kasalukuyang sistema ng pagpapalano ng programa sa Filipino ay nakasentro sa Komisyon sa Lalong Mataas na Edukasyon at sa mga may katungkulang magsagawa ng pagpaplanong ko-kurikular na gawain. Malimit inalis ang perspektibong maisangkot ang mga guro sa malawakang pagpaplanong pangwika. Kunsabagay, sa institusyonal na pagpaplanong, kung mayroon man, "malaki ang naiaambag ng mga guro upang maging kaaya-aya at kapaki-pakinabang ang pagpaplanong kurikulum at ang pagsasakatuparan ng mga gawaing ko-kurikular" (Richards, 2001).

#### 4.2. Mga Suliranin at Angkop na Solusyon ayon sa Pangangailangan

Ang mga nasumpungang suliranin sa programa sa Filipino ay nahahanay sa iba't ibang salik na may kaugnayan sa pagpaplanong akademikong programang pangwika, globalisasyon, elaborasyon,



at estandardisasyon ng wikang Filipino, pagsulat sa wikang Filipino, kagamitang pampagtuturo at pasilidad, implementasyon ng batayang kurikulum sa Filipino, mga ko-kurikular na gawain, programa sa Filipino, at ebalwasyon ng programang pangwika.

#### 4.3. Mga Saligan sa Pagbalangkas ng Isang Akademikong Modelong Pangwika

Maliban sa mga resulta ng deskriptibong paglalarawan sa kasalukuyang programa sa Filipino at sa mga nasumpungang suliranin na nilapatan ng angkop na solusyon, ang mungkahing akademikong modelong pangwika ay salig sa mga simulaing ipinahayag ng mga higante sa pagpaplanong pang-kurikulum at pangwika.

Ayon kay Bell (1991), ang modelo ay isang koleksiyon na nangangailangan ng mga simulain na siyang magsisilbing daluyan at batayan upang ang ibang bahagi nito ay makasunod alinsunod sa disenyo at katuturan nito.

#### Talahanayan 3. Mga Nakalap na Suliranin t Angkop Na Solusyon

Mga Suliranin	Mga Solusyon
1. <i>Pagpapalano sa Akademikong Programang Pangwika</i> – malimit na ang mga tagapagplano ng kurikulum ay mga indibidwal na may katungkulan na maari naming walang aktuwal na kontak sa mga mag-aaral	1. Inter-aktibo at alternatibong pagpapalano na humihimok ng isang sistemang nagsisimula sa mga tagapagpatupad ng kurikulum paakyat sa mga administrador o ang pagsangkot sa mga guro sa isang malawakang pagpapalano
2. <i>Globalisasyon</i> - sentro ng globalisasyon ang paghubog sa kasanayan ng mga mag-aaral sa wikang Ingles	2. Palawakin at palalimin ang kaalaman ng guro at mga mag-aaral sa Filipino upang magsilbing sandata sa paglaban sa mga pagbuburang ginagawa ng globalisasyon sa kultura, wika, kamalayan, at pagkatao ng mamayang Pilipino.
3. <i>Elaborasyon ng wikang Filipino</i> - walang nagsasagawa ng mga iskolarling pag-aaral at pagpapalimbag ng mga tesaurong maaring gabay sa pag-aaral ng wika	3. Magsagawa at magpalimbag ng mga tesauro sa Filipino na maging kaagapay ng lahat ng guro at mag-aaral sa pagpapalawak ng wikang pambansa. Magkaroon ng sapat na kaalaman at kasanayan sa pagsasalang-wika.
4. <i>Estandardisasyon ng Wikang Filipino</i> – maraming pagbabago sa anyo ng wikang Filipino dulot ng mga pagbabagong panlipunan	4. Magkaroon ng mas tama at angkop na norm upang magkaroon ng isang batayan o gabay sa paraang pagsulat sa Filipino
5. <i>Pagsulat sa wikang Filipino</i> – may kahinaan sa teknikal at malikhaing pagsulat	5. Dagdagan ang mga asignaturang sadyang lilingang sa malikhain at teknikal na kakayahang pagsulat ng mga mag-aaral  Bumuo ng mga lupon ng mga manunulat sa Filipino na lilingang sa kakayahang pagsulat ng mga guro at mag-aaral  Magsagawa ng mga pagsasanay sa mga manunulat o mag-aaral ng Filipino sa pamamagitan ng kumperensiya at seminar-worksyap  Bigyang pribilehiyo ang mga manunulat na magkaroon ng sariling publikasyon sa Filipino
6. <i>Kagamitang Pampagtuturo at Pasilidad</i> – kakulangan sa mga kagamitang pampagtuturo at pasilidad	6. Magtalaga ng sapat at angkop na mga kagamitang pampagtuturo upang epektibong maihatid sa mga mag-aaral ang bawat nilalaman ng kurso
7. <i>Implementasyon ng Batayang Kurikulum sa Filipino</i> – mababaw lamang ang pagkatuto ng mga mag-aaral sa Filipino at kulang ang lawak ng implementasyon sapagkat pilit isinasampa ang lahat ng kasanayang pangwika sa iisang asignatura	7. Palawakin o dagdagan pa ang mga asignaturang sadyang huhubog sa kasanayang pangwika ng mga mag-aaral upang lubos na maakamit ang kalidad ng pag-aaral at pagkatuto sa sariling wikang pambansa
8. <i>Ko-kurikular na Gawain</i> – halos walang bago sa mga ko-kurikular na gawain na siyang nagdudulot sa pagkasuya sa mga nakagawian na	8. Maaring magsagawa pa ng ibang bagong gawaing siyang magsusulong sa mas malalimang pagpapahalaga sa wikang Filipino
9. <i>Programang Filipino</i> – walang pormal, malinaw, at tiyak na patakarang pangwika na ipinapatupad sa bawat institusyon; walang malinaw na programa sa Filipino maglalarawan sa tunguhin at direksiyon ng wikang Filipino sa bawat pang-estadong institusyong akademiko sa rehiyon	9. Marapat na maisulong ang isang modelong akademikong pangwika na magsisilbing gabay ng bawat institusyon sa pagsasagawa ng mga programang pangwika
10. <i>Ebalwasyon ng Programang Pangwika</i> – walang regular na ebalwasyon sa mga programang pangwika	10. Magsagawa ng isang regular na ebalwasyon sa programang pangwika sa mga pang-estadong unibersidad at kolehiyo upang magkaroon ng empirikal na batayan ang pagsasaayos sa programa at upang matiyak kung tagumpay ang patakarang pangwika sa institusyon

May panawagan naman si Constantino (2005) na palawakin ang Filipino at ang pagpaplanong pangwika sa dimensiyong pananaliksik. Sa kanyang pagsulong sa mga gawaing pangwika, ipinahayag niya ang konsepto ng isang Deskriptibong Pagpaplanong Pangwika na tinatawag din namang Institusyonal na Pagpaplanong Pangwika na maaring maipamalas sa mga modelong maaring magamit bilang basehan nito. Ayon din kay Constantino, layunin ng pagpaplanong pangwika na lutasin ang mga problemang pangwika at ayusin ang mga sitwasyon at kalagayang pangwika sa pamamagitan ng mga mungkahing solusyon at manipulasyon tungo sa tahasang pagkilala sa wikang Filipino bilang asignatura at wikang pambansa.

Ipinamalas naman ni Haugen (1960), ang apat na proseso sa pagpaplanong pangwika, ang: (1) seleksiyon, (2) kodipikasyon, (3) elaborasyon, at (4) implementasyon. Sa antas rehiyonal, ang apat na prosesong nabanggit ay nasa yugto na ng pag-unlad.

bagama't hindi pa sapat ayon na rin sa mga nakalap na impormasyon, obserbasyon, at pagsusuring naganap sa pagsasakatuparan ng pag-aaral na ito.

Sa kabilang dako, isang napakalaking kontribusyon ang inilatag ni Tarun (2005) tungkol sa institusyonal na tunguhin sa pagpaplanong pangwika. Ayon sa kanya, ang isang modelong programang pangwika ay marapat na nakapokus sa apat na tunguhin ng institusyon: instruksiyon, riserts, ekstensiyon, at produksiyon. Ang apat na tunguhing ito ay nangangailangan ng seleksiyon na magamit ang wikang Filipino bilang wikang magtataguyod sa institusyonal na programa na angkop sa kakayahan ng bawat isa na umunawa at magpasiya ayon sa wikang nagpaparating ng mas masikhay na pagkaunawa. Maliban sa apat na tunguhing nabanggit, at batay na rin sa ginawang pag-aaral, marapat na isama ang ko-kurikular na programa sa pagbalangkas ng mga patakarang pangwika upang ganap na mahubog ang iba pang kakayahan at potensiyal ng mga mag-aaral.

Dagdag pa nito, ang isang programang pangwika ay magiging ideolohikal lamang kung ang proseso ng pagpapalaganap ay sistematik. Ayon kay Brown (1995), magiging sistematik ang proseso ng programa kung patuloy itong isalang sa mga ebalwasyong maglalatag ng empirikal na batayan sa pagpapaunlad ng programa. Ang programang may sistematik na proseso ay laging handang tumupad at tumanggap sa anumang pagbabago kung kaya, sa nagawang paglalarawan ng pagpaplanong pangwika, ang *cyclical* na paglalarawan ay sinikap ng manaliksik na iakma ito sa isang modelong sasapol sa pangangailangan ng isang sistematikong programang pangwika.

Sa mga resulta ng pananaliksik at sa pagpapatibay ng mga simulaing nabanggit, pinagsikapan ng mananaliksik na pagsamasamahin ang mga konseptong nakalap sampu ng mga resultang nagmula sa isang masusing pagsusuri sa ginawang deskriptibong paglalarawan sa tunay at kasalukuyang kaganapan ng programa sa Filipino sa Rehiyon III. Sa pamamagitan ng isang tumpak na pagpili sa mga simulaing pangwika, pagpaplano, at programa, matutunghayan sa susunod na bahagi ang produkto ng isang masusing paghimay, pagtumbok, at paglapat ng mga bahagi ng modelong angkop sa pangangailangan ng mga institusyon sa rehiyon.

#### 4.4. Mungkahing Akademikong Modelong Pangwika

Ang mungkahing modelong akademikong pangwika (Tingnan ang Apendiks, p. 19) ay deskriptibo lamang at hindi preskriptibo. Mula rito, nabuo ang isang mekanismo upang magkaroon ng malinaw na patakarang pangwika sa apat na tunguhin at sa iba pang gawain ng mga pang-estadong unibersidad at kolehiyo sa Rehiyon III: instruksiyon, riserts, ekstensiyon, at produksiyon maging sa mga gawaing ko-kurikular o ekstra-kurikular. Ang mga pangunahing yugto nito ay kinapalooban ng pagpaplano, disenyo ng patakarang pangwika, konsultasyon at diseminasyon, implementasyon, at ebalwasyon.

Ang modelo ay may limang pangunahing komponent: pagpaplano, disenyo ng patakarang pangwika, konsultasyon at diseminasyon, implementasyon, at ebalwasyon.

#### 4.4.1. Pagpapalano

Mula sa tipikal na ayos ng pagpapalano, isang alternatibong pagpapalano ang magaganap – mula sa ibaba paakyat. Ibig sabihin mababago ang sistema ng pagpapalano. Mag-uumpisa ang pagpapalano sa pamamagitan ng pagsusuri sa mga pangangailangan ng mga mag-aaral ng bawat pang-estadong institusyon upang malaman kung ano ang nalalaman at nararanasang kasanayan nila sa wika at kung ano pa ang kailangan nilang malaman at maranasan pa. Ito ay malalaman lamang ng mga guro sa pamamagitan ng isang masusing pag-aaral at pagsusuri sa pangangailangan ng kanilang mga mag-aaral. Magagawa ito sa pamamagitan ng mga pananaliksik, pagsusuri sa kanilang pangangailangan, at pagtalakay sa mga mag-aaral. Ang buong kaguruan ng Filipino ay marapat makisangkot sa ganitong gawain upang lahat ng uri ng mag-aaral ay makuhanan ng pahayag para sa pagdokumento ng mga pangangailangan at pagsusuri nito pagkatapos. Kapag nagawa na ito sa antas ng mga mag-aaral, marapat na magkaroon ng pagtalakay sa panig ng mga guro at mag-aaral tungkol sa mga nakalap na impormasyon. Marapat na anyayahan ng mga guro ang mga piling mag-aaral na makipagtalakayan sa kanila para sa pagdidisenyo ng isang programang pangwika. Sa pamamagitan nito, mababatid ng husto ang maari at hindi maaring isama sa mga patakaran na hindi naman mapupuwertisado ang tunguhin at layunin ng unibersidad o kolehiyo.

Sa nadisenyong programa, kinakailangang maipakita sa mga eksperto ng wika ang mga nagkasunduang mga patakaran at gawain. Dito makakakuha ng mga intelektuwal na komento upang lalong mapabuti ang disenyo ng programa. Kung ang mga mungkahi ay makakabuti para sa lahat, mainam na iayos pa ang disenyo bago tuluyang iakyat sa mga kinauukulan. Mainam na rin kung ang naisagawang disenyo ng programa ay idudulog sa mga administrador kasama ang mga grupong nakibahagi sa pagpapalano. Kung gayon, sa huling antas ng pagpapalano, marapat magkaroon ng isang intelektuwal na talakayan ang mga mag-aaral, guro, eksperto at mga punong administrador upang mailatag ang isang programang pangwika na tutugon sa pangangailangan ng mag-aaral, unibersidad o kolehiyo.

Ang paglalarawan ay isang ideolohiko kung hindi isang alternatibong uri ng pagpapalano ng isang programa. Nag-uumpisa ang pagpapalano sa mababa patungo sa itaas, isang paraan upang maging aktibo ang lahat sa pakikibahagi sa pagpapalano pangwika. Ito ang magpapahina sa nakauugali ng pagpapalano mula sa mga administrador o eksperto patungo sa mga tagatanggap na guro at mag-aaral. Ang pagpapalano sangkap ay maliwanag na inter-aktibo at kumikilala sa kakayahan ng mga guro na makabuo ng isang disenyong pangwikang aakma sa mga mag-aaral na tatanggap nito.

#### 4.4.2. Disenyo ng mga Patakarang Pangwika

Ang mga patakaran, ayon kay Abad (2005), ay nagsisilbing malawak na pamantayan sa mga desisyon at kilos na kinakailangan sa pagkakamit ng mga layunin ng organisasyon na nakapaloob sa mga planong nabuo. Ang modelo kung gayon ay naglalarawan ng isang programang pangwika na kinapapalooban ng mga patakaran nito. May malaking tungkulin sa pagtataguyod, pagpapayaman, at pagpapanatili ng wikang Filipino ang mga kasangot na institusyon sa rehiyon. Upang matunghayan at masuri ang mga gawaing pangwika na isinagawa at isasagawa pa, inilalahad ng deskriptibong modelo ang programang pangwika sa apat na tunguhin at iba pang gawain ng institusyong pang-estado:

##### 4.4.2.1. Instruksiyon

Ang antas ng talakayan sa programang ito ay ayon sa mga asignaturang napapaloob sa General Education Curriculum lamang. Subalit, kahit hindi naka-angkas ang ibang programang pang-disiplina sa Filipino sa batsilyer at gradwadong antas, maari rin namang gawing basehan ang mga kurikular na gawain sa General Education Program sa Filipino sa mga mas mataas pang pag-aaral sa Filipino.

Upang mabigyan ng makabagong instruksiyon ang mga mag-aaral sa iba't ibang larangan, narito ang mga panuntunang marapat maisagawa:

#### **4.4.2.1.1. Regular na rebisyon ng silabus**

Hindi dapat makontento ang mga guro sa mga nilalaman ng silabus. Kailangang magsagawa ng isang regular na pag-apdeyt sa mga ito upang magkaroon ng pagbabago o lalao na ang pagdaragdag ng mga kaugnay na paksa mula sa mga natutunan sa gradwadong paaralan, sa mga naba-basa sa mga makabagong aklat o reperensiya, sa mga dinaluhang seminar-worksyp, kumperensiya, pagsasanay, at pagtalakay.

#### **4.4.2.1.2. Komon at singkronisasyon ng mga silabus**

Upang maiwasan ang problema sa inter-kampus o inter-kolehiyong lipatan, gawing komon ang mga silabus sa bawat asignatura sa Filipino upang tumugma ang mga ito sa singkronisasyon.

#### **4.4.2.1.3. Kodipikasyon ng wikang Filipino**

Upang makagawa ng iba pang kagamitang pampagtuturo, kailangang mapasok ng mga kaguruan ang paggawa ng mga diksiyunaryo, aklat, workbuk, modyul, at iba pa. Layunin nitong mapalawak ang kagamitang pampagtuturo maliban sa mga nakapaloob sa silabus. Gamitin din ang wikang Filipino sa mga opisyal na komunikasyon sa mga akademiko at administratibong opisina sa loob ng unibersidad o kolehiyo.

#### **4.4.2.1.4. Elaborasyon ng wikang Filipino**

Isalin ang mga pangalan ng unibersidad, kolehiyo, at mga opisina; ang mga pilosopiya, tunguhin at layunin ng mga programa; mga babala, karatula o paunawa maging ang mga rehiyonal na panitikan upang lalong makamit ang elaborasyon ng wika.

Gawing paksa at gawain ang pagsasaling-wika sa mga batayang kurso sa Filipino. Malaki ang maiaambag nito sa ibang programang nangangailangan ng pagsasalin mula Ingles tungo sa Filipino.

#### **4.4.2.1.5. Pagpapayaman sa panitikan**

Isama sa pagtuturo at pag-aaral ang mga rehiyonal o katutubong panitikan upang imulat at linangin sa mga mag-aaral ang pagpapahalaga at pagtangkilik sa kanilang katutubong kultura. Sa pagkalap ng mga katutubong piyesa, makakapagsagawa din ng ilang pag-aaral tungo sa pagbuo ng mga glosaryo sa unang wika at pagsasalin din naman sa wikang Filipino.

#### **4.4.2.1.6. Pagpapaunlad sa mga kasanayang pangwika**

Paunlarin ang kasanayang pangwika sa pamamagitan ng mga batayang kurso sa Filipino. Magpagawa sa mga mag-aaral ng mga pamanahong papel o pagtatanghal ng panapos na gawain upang maipamalas nila ang kanilang natutunana sa buong semestre ng pag-aaral sa wikang Filipino.

Ang mga panuntunang hindi nakapaloob sa bahaging ito ay maari rin namang maisagawa nang may pagsasaalang-alang sa mga patakarang nauna nang nailatag ng Komisyon ng mas Mataas na Edukasyon.

#### **4.4.2.2. Riserts**

Tunguhin ng modelong ito na makilala ang Filipino bilang isang opisyal na wika ng riserts sa lahat ng pang-estadong unibersidad at kolehiyo ng Rehiyon III. Mapapansin ang kakulangan ng mga reperensiyang tesis at disertasyon ng mga mag-aaral na nasa batsilyer at gradwadoong antas sa mga pang-estadong institusyon. Ingles ang wikang kinikilala sa riserts at masusumpungan lamang ang Filipino sa mangilan-ngilang pag-aaral sa mga mag-aaral na nasa erya ng pagpapakadalubhasa sa Filipino, at alternatibong wika naman ito sa mga pananaliksik sa Kasaysayan o *history* at sikolohiya.

Dahil sa masaklap na posisyon ng wikang Filipino sa programang pang-riserts, maaring isaaalang-alang ang mga sumusunod upang maging kaaya-aya ang pagsulat ng riserts gamit ang wikang pambansa:

#### **4.4.2.2.1. Paggamit ng bagong ortograpiya**

Gamitin ang binagong edisyon ng ortograpiya mula sa Komisyon ng Wikang Filipino. Magkaroon ng mga kumperensiya at worksyap upag magkaroon ng kamalayan sa ortograpiyang Filipino sa mga mananaliksik sa antas batsilyer at gradwadong pag-aaral maging sa mga gurong mananaliksik sa erya ng siyensiya at teknolohiya at riserts sa agham panlipunan at mataas na edukasyon.

#### **4.4.2.2.2. Kilalanin ang Filipino bilang wika ng riserts**

Gawing opisyal at hindi alternatibong wika ang Filipino sa kahit anong erya ng riserts: siyensiya at teknolohiya at agham panlipunan at mataas na edukasyon. Obligado lamang itong hindi dapat magamit sa mga riserts ng mga mag-aaral o gurong nagpapakadalubhasa sa Ingles. Sa ganitong sitwasyon, mas madali ang pagpapatid ng mga resulta ng pag-aaral sa buong komunidad.

#### **4.4.2.2.3. Bumuo ng mga jornal sa Filipino**

Isilang ang mga eksklusibong jornal na maglalathala sa mga riserts na nasusulat sa wikang Filipino. Hikayatin ang mga guro at mag-aaral na magsagawa ng mga riserts sa Filipino o kaya naman ay isalin ang anumang maisasagawa sa Ingles para sa kapakinabangan ng mga mananaliksik sa hinaharap, mga mag-aaral, guro, at maging ang komunidad.

#### **4.4.2.2.4. Pagsasanay sa pagsasaling-wika**

Isang masikhay na seminar-worksyap at pagsasanay sa pagsasaling-wika ang dapat maipaabot sa mga mag-aaral at guro sa antas batsilyer at gradwado. Sa pagsasagawa ng riserts sa Filipino, ang pagsasalin ay sadyang kailangan at hindi maiiwasan sapagkat malayong mas maraming mga reperensiya ang nasusulat sa Ingles na kapaki-pakinabang para magamit sa mga kaugnay na panitikan at pag-aaral. Dahil dito, marapat na malinang ang kaalaman at kasanayan ng mga mananaliksik sa pagsasalin mula Ingles tungo sa Filipino.

Malaki ang maitutulong ng mga gawaing nabanggit upang makilala ang Filipino bilang opisyal na wika ng riserts. Kapag naisagawa ang mga ito, hindi malayong maging kalugod-lugod ang wikang Filipino sa pagsulat ng mga riserts sa erya ng siyensiya at teknolohiya at sa agham panlipunan at mataas na edukasyon.

#### **4.4.2.3. Ekstensiyon**

Nakapokus ang mga programa ng ekstensiyon sa pagbibigay impormasyon at pagtulong sa mga mamamayan sa labas ng unibersidad o kolehiyo. Sa pagsasagawa ng mga programang pangkomunidad gaya ng seminar-worksyap at pagsasanay at sa implementasyon ng mga proyekto ng ekstensiyon maging sa pagpapalaganap ng mga bagong tuklas na karunungan sa siyensiya at teknolohiya at resulta ng pag-aaral sa agham panlipunan at mataas na edukasyon, dapat umiral ang wikang Filipino at bernakular. Dagdag pa rito, marapat makagawa ang opisina ng ekstensiyon ng mga brosyur, pahayagan, magasin o jornal na nakasulat sa Filipino upang maipamudmod para mas madali at mabisa ang paghahatid ng impormasyon sa mga mamamayan sa komunidad. Sa pamamagitan nito ay higit na mapapaigting o mapapalaganap ang programang ekstensiyon ng bawat pang-estadong unibersidad at kolehiyo sa rehiyon.

#### **4.4.2.4. Produksiyon**

Naipapabatid ng husto ang mga bunga ng pag-aaral at bagong teknolohiya sa pamamagitan ng wikang Filipino. Higit itong epektibo sa pag-aanunsiyo tungkol sa mga ibinebentang produktong naprodyus ng unibersidad o kolehiyo at sa pagpapaliwanag at paghihikayat ng mga tao lalo na sa mga ordinaryong mamamayan.

Tulad sa ekstensiyon, lalong matagumpay ang tunguhin ng programa kung makakagawa ng mga pamplet, brosyur, pahayagan, magasin, o jornal na nakasulat sa wikang Filipino.

Sa mga gurong nais magsalin at magsulat ng mga aklat sa Filipino, gaya ng Unibersidad ng Pilipinas, isang magandang panghikayat ang pagbibigay sa kanila ng insentib o gantimpala sa anumang mapoprodyus nilang magagamit sa pagtuturo at pagkatuto sa wikang Filipino.

#### **4.4.2.5. Ko-kurikular o Ekstra-kurikular**

Susunod ang mga gawaing maaring isagawa upang higit na mapaigting ang pagpapahalaga sa wika at kultura sa pamamagitan ng wikang Filipino:

##### **4.4.2.5.1. Pahalagahan ang wikang Filipino sa publikasyong pangkampus**

Gawing 50-50 ang kabuuang bahagdan ng paggamit ng Ingles at Filipino sa mga publikasyong pangkampus. Dito masisilayan ang pantay na pagpapahalaga sa dalawang wika na siyang magsisilbing paraan upang makahikayat ng mga manunulat na mag-aaral at guro sa Filipino. Dito mapapawi ang higit na pagkiling sa wikang Ingles at mabigyan ng angkop na posisyon ang Filipino sa publikasyong pangkampus.

##### **4.4.2.5.2. Bumuo ng mga organisasyong eksklusibo para sa mga manunulat sa Filipino**

Institusyonal at rehiyonal na antas, isang organisasyon ng mga mag-aaral at gurong manunulat sa Filipino ang dapat mabuo. Tunguhin ng organisasyon na malinang ng husto ang kakayahan ng mga ito sa pagsulat ng mga malikhain at teknikal na pagsulat at makapagprodyus ng mga makabagong manunulat sa rehiyon.

##### **4.4.2.5.3. Pakikibahagi tuwing Buwan ng Wika**

Isangkot ang lahat ng kolehiyo at opisina ng institusyon sa mga gawain tuwing pagdiriwang ng Buwan ng Wika. Magsagawa ng mga gawain upang ang lahat ay makibahagi sa panahon ng pagdiriwang at maipaalala sa kanila ang kahalagahan ng wikang nagbubuklod sa lahat ng mamayan sa bansa. Marapat na isang gawaing pang-unibersidad ang pagdiriwang at hikayatin ang lahat ng kolehiyo at opisina ng makiisa sa pagdiriwang. Maaari ring ipatupad sa buong unibersidad at kolehiyo ang hindi pagsasalita ng Ingles (*English blackout*) upang maiba naman at maging ganap ang pagdiriwang ng Buwan ng Wika.

##### **4.4.2.5.4. Magsagawa ng mga bagong gawaing ko-kurikular**

Maliban sa mga kinagawiang ko-kurikular, magsanay at magtanghal ng iba pang gawain sa Filipino. Institusyonal at rehiyonal na antas, magsagawa ng mga patimpalak sa pagsasalina ng mga himno ng unibersidad o kolehiyo gamit ang wikang Filipino, pagsulat ng iskrip-sayaw (*dance script*) mula sa isinaling katutubong panitikan, at pagsulat akrobatiko gamit ang mga letra ng pangalan ng mga pangulo bilang pagpaparangal sa kanila.

##### **4.4.2.5.5. Gawing regular ang pagtatanghal sa mga palabas kultural**

Sikapang regular ang pagtatanghal ng mga palabas kultural gaya ng Sayawit at Sayaw-dula. Buhayin din at regular na itampok ang Balagtasang upang lalong mapahalagahan ang kultura at wikang minana.

#### 4.4.2.5.6. Magsagawa ng mga kumperensiya, seminar-worksyap, at pagsasanay sa Filipino

Kulang sa pagsasanay sa wikang Filipino ang mga mag-aaral. Bunsod na rin ito ng mga institusyong hindi nagsasagawa ng mga kumperensiya, seminar-worksyap, at pagsasanay sa Filipino para sa mga mag-aaral. Mainam na isama ito sa mga taunan at matagalang pagpapalano ng mga guro. Si-kapin ding makabuo ng mga organisasyon sa Filipino na maging katuwang sa pagbuo at pagsasagawa ng mga ganitong akademikong gawain.

#### 4.4.2.5.7. Magbigay ng mga nararapat na gantimpala para sa mga mag-aaral

Kilalanin ng husto ang mga mag-aaral na nakikisangkot at nanalo sa mga pampanitikan at kultural na gawain. Dito lamang mababawi ang pagod at pagsisikap sa pagpappalaganap ng wika at kulturang Pilipino. Sa paraang ito, lalo silang mahihikayat na makibahagi sa mga ko-kurikular na gawain sa Filipino.

Ang mga nabanggit ay ilan lamang sa mga gawaing dapat isaalang-alang upang makomplemento ang kurikulum at magsisilbing paraan upang lalong mahasa ang kasanayang pangwika ng mga mag-aaral at mapaigting sa diwa ng bawat isa ang pagpapahalaga sa wika at kultura.

#### 4.4.3. Konsultasyon at Diseminasyon

Pangatlong yugto ng mungkahing modelong pangwika ang konsultasyon at diseminasyon. Mauuna nga lamang na maisasagawa ang konsultasyon sa mga nabalangkas na programang pangwika bago ang tuluyang diseminasyon nito. Marapat na magkaroon ng paghihimay sa mga napapaloob na mga gawaing pangwika at mailahad ito sa mga administrador, eksperto, guro, at mag-aaral sa antas institusyonal bago ito mailahad din sa antas rehiyonal at nasyonal, kung kinakailangan. Anumang mungkahing maibigay ng mga sangkot sa konsultasyon ay marapat mapag-aralan, masuri, at kung kapaki-pakinabang ay maisama sa programang pangwika. Mahalagang salik ito sa pagpapalano sapagkat walang matagumpay na patakarang hinubog lamang ng isang kamalayan, marapat itong mabuo ng mga taong kasangkot sa pagpapatupad at pagsasakatuparan nito (Richards, 2001). Samantala, ang konsultasyon ay nagdidikta ng bahagya o inisyal na diseminasyon sa balangkas ng programa, subalit ang ganap na diseminasyon nito ay dapat maisakatuparan upang maging malinaw, tumpak, buo o kumpleto ang impormasyong maipapahayag tungo sa ganap na implementasyon nito.

#### 4.4.4 Implementasyon

Isa ring pangunahing gawain sa deskriptibong modelong pangwika ang implementasyon ng mga patakaran. Bigyang pansin ang pagpapatupad dahil walang tiyak na kaganapan ng mga plano at programa kung hindi ito maisasagawa ng maayos. Subalit hindi lang dapat implementasyon ang hangganan nito. Kailangan din ang masusing pagsubaybay o pagmomonitor sa mga naisagawa ng bahagi ng mga patakaran bilang kalakip ng pamamanihalang pangwika.

Hinihingi ng programa ang pamamanihala rito kaya, maliban sa Komisyon ng Wikang Filipino, marapat makabuo ng isang lupon ng mga eksperto sa Filipino sa Rehiyon III. Isang kinatawan ng bawat pang-estadong unibersidad o kolehiyo ang dapat kasama sa grupong ito upang maging katuwang sa implementasyon ng programang pangwika. Hinihimok din ang ilang mga administrador sa mga pang-estadong unibersidad at kolehiyo na walang eksklusibong Departamento ng Filipino na pag-isahin ang lahat ng mga guro sa Filipino sa pamamagitan ng pagbibigay sa kanila ng isang akademikong tanggapang mamanihala at magsusulong sa mga programang pangwika ng bawat institusyon. Ang pagkilala sa mga ganitong tanggapan ay dapat mabigyan ng sapat na suporta upang maging masikhay ang implementasyon ng mga programa.

#### 4.4.5. Ebalwasyon

Ang konsepto ng ebalwasyon ang malimit isinasantabi sa alinmang programang pangwika. Sanhi ito ng mga rasyonal at politikal na dahilan lalo na at may kaugnayan sa malakihang gastusin o budget. Kung kaya, ang mga programa ay laging nagtatapos sa implementasyon at nakakalimutan o napapabayaang aspetong ebalwasyon. Sa isang akademikong modelong pangwika, ito ang huling yugto ng proseso subalit hindi ito nangangahulugang hangganan kundi umpisa na naman ng ibang gawaing siyang maglilinig, magpapa-unlad, magpapalakas at magpapatuloy sa kabuuang proseso ng programang pangwika.

Ang resulta ng ebalwasyon ang siyang magsasabi kung anong uri ng gawain ang dapat maisagawa sa pagpapatuloy ng programa. Kung naging maganda ang kinalabasan ng ebalwasyon, marapat na paigtingin, palakasin at lalong pagyamanin ito. Subalit kung may mga kahinaan man ang programa, nangangailangan ito ng pagpaplanong muli at pagsasaayos ng mga patakaran at gawaing pangwika.

Tunguhin ng ebalwasyon na alamin ang kahalagahan ng akademikong programang pangwika. Nagsisilbi itong batayan sa pagdedesiyon at pagpapaunlad ng programa sa hinaharap.

Sa pamamagitan ng mungkahing akademikong modelong pangwika na tinangkang binuo bilang bunga ng pag-aaral na ito, mabibigyang linaw ang landas na tinatahak ng wikang Filipino sapagkat ang mga naihaing patakarang pangwika ang siyang gagabay at magbibigay direksiyon tungo sa programang magpapalawak at tuluyang magpapalaganap nito. Dahil din dito, ipinapahiwatig ng modelo ang mahigpit na pangangailangan ng mga guro, eksperto, at kawaning may sapat na kakayahan at kahusayan sa pamumuno at pangunguna sa mga programang kaugnay ng malawakang pagpapalaganap ng pambansang wikang Filipino.

### 5. Konklusyon

Malaki ang impluwensiya ng Komisyon ng Lalong Mataas na Edukasyon sa mga simulain at kaganapan ng mga programang pangwika. Naging mahigpit ang pananaw sa bawat panuntunang isinaad ng komisyon sa parehong pagtuturo at pagkatuto sa wikang Filipino sa lahat ng pang-estadong unibersidad at kolehiyo sa Rehiyon III.

2. Ang tunay na kaganapan ng kurikulum sa Filipino maging ang mga gawaing ko-kurikular ay nakasalalay sa bisang taglay ng mga patakarang naipapatupad sa nasyonal, rehiyonal, at higit sa lahat sa institusyonal na konteksto. Hindi pa ganap na naaabot ang tunay na tunguhin o lawak ng programa sa Filipino lalo na at walang pormal, tiyak, at malinaw na pagpaplanong pangwika sa bawat pang-estadong unibersidad at kolehiyo sa Rehiyon III.
3. Sa patuloy na pagbuo ng mga bagong kaisipan sa konteksto ng kurikulum ng may mataas na pagpapahalaga sa wika at kultura, mabibigyang saysay ang tunay na kaganapan ng wikang Filipino sa isang akademikong aspeto. Kaya, ang pag-aaral ng wika ay hindi dapat nakahiwaly sa pagpapahalaga ng kultura at sa paglalalapat sa tunay na gamit ng wika. Samakatuwid, nangangailangan ang kurikulum ng mga gawaing magbibigay diwa o kaganapan nito – ang ko-kurikular na aspeto ng pag-aaral ng wika at kultura.
4. Ang mga suliranin sa programa sa Filipino ay nahahanay mula sa iba't ibang salik institusyonal hanggang sa rehiyonal, nasyonal, at global na perspektibo. Mga patakarang pangwika at mga lupon ng ekspertong siyang mamanihala at magsusulong sa mga gawaing pangwika ang magiging susi sa malawakang pagpapalaganap ng isang programang pangwika.
5. Upang magkaroon ng koneksiyon ang bawat punto ng layunin, ang isang mungkahing akademikong modelong pangwika ay marapat na nakaangkla sa mga simulaing nagbibigay gabay o pokus sa pagkakabuo nito.



6. Mula sa deskriptibong pagpapalano at pagbuo ng mga patakarang pangwika sa apat na tunguhin at iba pang programa ng mga pang-estadong institusyon hanggang sa isang masikhay na diseminasyon, implementasyon, at ebalwasyon nito, mapagtibay ang malaking pagpapahalaga sa pagpapaunlad ng wikang Filipino. Walang mga modelo at patakaran ang makapagbibigay tuldok sa patuloy na pag-aaral at pagsasakatuparan ng mga programang pangwika.

## 6. Rekomendasyon

1. Pag-aralan pa ng may kasikhayang kurikulum sa Filipino. Ang tunguhin, lawak o bilang ng yunit sa bawat disiplina, nilalaman, organisasyon, kagamitang pampagtuturo, pasilidad at ebalwasyon nito ay marapat isaalang-alang upang maging kapaki-pakinabang ang buong programa.
2. Gamitin ang wikang Filipino sa mga opisyal na komunikasyon sa mga akademiko at administratibong opisina sa loob ng unibersidad o kolehiyo.
3. Magsagawa ng mga pagsasanay sa pagsulat ng wikang Filipino sa pamamagitan ng mga kumperensiya at seminar-worksyap, pagbuo ng mga organisasyon ng mga manunulat sa Filipino, pagbibigay ng pribilehiyo sa mga manunulat na magkaroon ng sariling publikasyon sa Filipino, pagpapalimbag ng mga malikahain at teknikal na papel sa Filipino, at pagdaragdag ng mga asignatura sa Filipino na lilingang sa kakayahang pagsulat ng mga mag-aaral.
4. Hangga't maaari, gawing masikhay ang pagtuturo sa wikang Filipino upang makamit ang tunguhing gawing matatas sa Filipino ang mga mag-aaral lalo na at galing sila sa iba't ibang pangkat etniko na may dala-dalang unang wikang sinasalita.
5. Bigyang pansin ang elaborasyon ng wikang Filipino sa pamamagitan ng paggawa at pagpapalimbag ng mga tesaurus at ang pagsasanay mga guro at mag-aaral sa pagsasalang-wika. Isalin sa wikang Filipino ang pangalan ng unibersidad at/o kolehiyo pati ang mga opisina o tanggapan nito maging ang pilosopiya, mga mithiin, layunin at programa upang lalong maramdaman ang tahasang pagpapalaganap ng nasyonalismo, lalong-laong na sa institusyong akademiko na siyang nagsusulong sa tunay na kaganapan ng wikang Filipino.
6. Maaring gawing batayan sa programang pangwika ang mungkahing akademikong modelong pangwika. Sa pamamagitan ng modelong ito, ang bawat pang-estadong unibersidad at kolehiyo sa rehiyon ay magkaroon ng isang deskriptibong modelo na maari nilang maging batayan sa kanilang mga programa at patakarang pangwika.
7. Isangkot sa pagpapalano ng pangwika ang mga guro at mag-aaral sa Filipino. Dapat mag-uumpisa ang pagpapalano sa mababa patungo sa itaas. Ang pagpapalano ng sangkap ay maliwanag na inter-aktibo at kumikilala sa kakayahan ng mga guro na makabuo ng isang disenyong pangwikang aakma sa mga mag-aaral na tatanggap nito.
8. Sa programang pang-instruksiyon, magsagawa ng regular na rebisyon ng silabus, gawing komon at may singkronisasyon ang mga ito, bigyang pansin ang kodipikasyon ng wikang Filipino, pahalagahan ang elaborasyon ng wikang Filipino, pagyamanin ang panitikan, at paunlarin ang mga kasanayang pangwika.
9. Sa programang riserts, isama sa tuntunin ang paggamit ng bagong ortograpiya, pagkilala sa Filipino bilang wika ng riserts, at pagsilang ng mga jurnal sa Filipino, at pagsasanay sa pagsasalang-wika.
10. Gamitin ang wikang Filipino sa pagsasagawa ng mga programang pangkomunidad upang mapadali at mabisa ang paghahatid ng impormasyon. Sa pamamagitan nito, higit na mapapaigting o mapapalaganap ang programang ekstensiyon ng bawat pang-estadong unibersidad at kolehiyo sa rehiyon.
11. Ipabatid ang mga bunga ng pag-aaral at bagong teknolohiya sa pamamagitan ng wikang Filipino. Higit itong epektibo sa pag-aanunsiyo tungkol sa mga ibinebentang produktong napoprodyus ng unibersidad o kolehiyo at sa pagpapaliwanag at paghihikayat ng mga tao lalo na sa mga ordinaryong mamamayan. Tulad sa ekstensiyon, lalong matagumpay ang tunguhin ng programa kung makakagawa ng mga pamplet, brosyur, pahayagan, magasin, o jurnal na nakasulat sa wikang Filipino.

12. Sa ko-kurikular o ekstra-kurikular na mga gawain, pahalagahan ang wikang Filipino sa publikasyong pangkampus, bumuo ng mga organisasyong eksklusibo para sa mga manunulat sa Filipino, makibahagi tuwing Buwan ng Wika, magsagawa ng mga bagong gawaing ko-kurikular, gawing regular ang pagtatanghal sa mga palabas kultural, magsagawa ng mga kumperensiya, seminar-worksyap at pagsasanay sa Filipino, at magbigay ng mga nararapat na gantimpala para sa mga mag-aaral.
13. Ipatatag ang mga patakaran o programang pangwika sa pamamagitan ng isang malawakang konsultasyon at diseminasyon bago ang tuluyang implementasyon ng mga plano at patakaran na itatampok sa isang akademikong modelong pangwika. Bigyang pansin ang regular na ebalwasyon ng mga naipatupad na programa upang magkaroon ng pormal na basehan sa pagpapayaman at pagpapabago ng mga programa.
14. Magtalaga ng mga guro, eksperto, at kawaning may sapat na kakayahan at kahusayan sa pamumuno at pangunguna sa mga programang kaugnay ng malawakang pagpapalaganap ng pambansang wikang Filipino. Isang kinatawan ng bawat pang-estadong unibersidad o kolehiyo ang dapat kasama sa grupong ito upang maging katuwang sa rehiyonal na implementasyon ng programang pangwika.
15. Bigyan ng sariling opisina ang mga guro sa Departamento ng Filipino sa bawat pang-estadong unibersidad at kolehiyo na siyang mamanihala at magsusulong sa mga programang pangwika ng bawat institusyon. Ang pagkilala sa mga ganitong tanggapan ay dapat mabigyan ng sapat na suporta upang maging masikhay ang implementasyon ng mga programa.
16. Bigyan ng insentib o gantimpala ang mga gurong makikibahagi sa mga pagsasalin at pagsulat sa Filipino upang lalo silang mahikayat na makibahagi sa pagsulong ng wikang pambansang Filipino.

## Bibliyograpiya

- Abad**, M. L. (2005). Panimulang Pagsusuri sa Patakarang Pangwika ng Unibersidad ng Pilipinas. Sa *Filipino at Pagpaplanong Pangwika: Ikalawang Sourcebook ng SangFil* na inedit ni Pamela C. Constantino. Sanggunian sa Filipino, UP Sentro ng Wikang Filipino-Diliman, at Pambansang Komisyon para sa Kultura at mga Sining.
- Baquiran**, D. A. (2010). *Ebalwasyon ng Pampagtuturong Programa ng General Education sa Filipino ng Technological University of the Philippines (TUP): Basehan sa Pagpapaunlad ng Kurikulum*. Dinalathalang tesis, Philippine Normal University.
- Bell**, R. T. (1991). *Translation and translating: Theory and practice*. London: Longman group.
- Biglete**, A. E. (2001). *Asia-Pacific Centre of Educational Innovation for Development*. UNESCO Asia and Pacific Regional Bureau for Education, Philippines. [webmaster@unescoebkk.org](mailto:webmaster@unescoebkk.org).
- Bobbit**, J. F. (1918). *The Curriculum*. Boston, USA: Allyn & Bacon, Inc.
- Brown**, J. D. (1995). *Elements of language curriculum: A systematic approach to program development*. Boston: Heinle and Heinle Publishers.
- Constantino**, P. C. (ed.). (2005). *Filipino at Pagpaplanong Pangwika: Ikalawang Sourcebook ng SangFil*. Sanggunian sa Filipino, UP Sentro ng Wikang Filipino-Diliman, at Pambansang Komisyon para sa Kultura at mga Sining.

- Francisco, C. G.** (2006). *Ang Intelektuwalisasyon ng Wikang Filipino*. Mula sa: [ccfrancisco@yahoo.com/mgababasahinfili123/kph/030106](mailto:ccfrancisco@yahoo.com/mgababasahinfili123/kph/030106).
- Ferguson, C. A.** (1977). *Language Planning Processes*. Inedit ni J. A. Fishman et al. The Hague: Mouton Publishers.
- Gonzalez, A.** (1990). Evaluating Bilingual Education in the Philippines: Towards a Multidimensional Model of Evaluation in Language Planning. Sa *Readings in Philippine Sociolinguistics*, Pangalawang edisyon na inedit ni Ma. Lourdes S. Bautista. Manila: De La Salle University Press.
- Haugen, E.** (1970). *Advances in language planning*. Netherlands: Mouton, The Hague.
- Komisyon sa Wikang Filipino.** (2009). *Gabay sa Ortograpiyang Filipino*. Manila.
- Inalvez, D. T.** (1999). *Ebalwasyon ng Pampagtuturong Programa sa Pilipino sa mga Mag-aaral sa Kolehiyo*. Di-nalathalang disertasyon, Philippine Normal University.
- Liwanag, L. B.** (1996). *Tawid-bansang Pag-aaral sa Pagpaplanong Pangwika sa Edukasyon sa Pilipinas, Singapore, at Hongkong*. Nalathalang disertasyon, University of the Philippines.
- Lumbrera, S. N.** (2005). Ang Pagsasalin ng mga Telenobela sa Filipino. Sa *Filipino at Pagpaplanong Pangwika: Ikalawang Sourcebook ng SangFil* na inedit ni Pamela C. Constantino. Sanggunian sa Filipino, UP Sentro ng Wikang Filipino-Diliman, at Pambansang Komisyon para sa Kultura at mga Sining.
- Magracia, E. B.** Pamamahala at patakarang sa Filipino ng Mindanao State University: Filipino bilang kurikular na pangangailangan. Sa *Filipino at Pagpaplanong Pangwika: Ikalawang Sourcebook ng SangFil* na inedit ni Pamela C. Constantino (2005). Sanggunian sa Filipino, UP Sentro ng Wikang Filipino-Diliman, at Pambansang Komisyon para sa Kultura at mga Sining.
- Miclat, M. I.** (2005). Wika at Globalisasyon. Sa *Filipino at Pagpaplanong Pangwika: Ikalawang Sourcebook ng SangFil* na inedit ni Pamela C. Constantino. Sanggunian sa Filipino, UP Sentro ng Wikang Filipino-Diliman, at Pambansang Komisyon para sa Kultura at mga Sining.
- Peña, R. P. et al.** (2007). *Pananaw ng mga Piling Mag-aaral sa UP, PUP at PNU sa Kurikulum ng Programang Pangkoleiyo na may Malaking Kinalaman sa Pagpapangatili at Pagpapaunlad ng Wikang Filipino*. Di-nalathalang tesis, Polytechnic University of the Philippines.
- Pineda, P. B. P.** (1985). Pagpaplanong Wika Ukol sa Pambansang Pagsulong. Sa *Readings in Philippine Sociolinguistics*, Pangalawang edisyon na inedit ni Ma. Lourdes S. Bautista. Manila: De La Salle University Press.
- Richards, J. C.** (2001). *Curriculum Development in Language Teaching*. Cambridge: Cambridge University Press.
- Rodgers, T. S.** (1989). *From Syllabus Design to Curriculum Design*. USA: University of Hawaii, Oahu, Hawaii.
- Sibayan, B. P.** (1991). The Intellectualization of Filipino. Sa *Readings in Philippine Sociolinguistics*, Pangalawang edisyon na inedit ni Ma. Lourdes S. Bautista. Manila: De La Salle University Press.
- Tarun, J. Z.** (2005). Pagpaplanong Pangwika para sa Pambansang Wika ng Isabela State University. Sa *Filipino at Pagpaplanong Pangwika: Ikalawang Sourcebook ng SangFil* na inedit ni Pamela C. Constantino. Sanggunian sa Filipino, UP Sentro ng Wikang Filipino-Diliman, at Pambansang Komisyon para sa Kultura at mga Sining.

# Exploring Mental Health Stigma and its Relationship to College Students' Help-Seeking Behavior

Laarni T. Capinding, Daniel T. Dizon and Editha Q. Villavicencio  
College of Arts and Social Sciences  
Tarlac State University

**Abstract:** College students' experience psychological distress but are reluctant to access the help that they need. Exploring the stigma on mental health and intention to seek help is essential towards understanding and promoting mental health. There are four main findings on this study: (a) the perceived public stigma of the students is higher than that of personal stigma; (b) a higher help-seeking intention for informal sources of help (c) perceived public stigma was positively associated in seeking help with an intimate partner and negatively associated with seeking help with other relative or other family members; and (d) personal stigma was associated with seeking help with other relatives or family members, phone helpline and not seek help from anyone. Findings have implications for addressing the stigma, provision of assessment and intervention, and advocacies to help break the stigma on mental health and to encourage use of available services to those students needing care.

**Keywords:** mental health, perceived public stigma, persona stigma, help-seeking, college students

## 1. Introduction

People perceive mental health differently than that health in general. The public is not yet receptive in talking and speaking up about this issue as the stigma of being judged, rejected and ridiculed becomes a barrier for seeking help. Unmanaged stress, anxiety, depression and suicide are some of the mental health concerns faced by individuals today. Students, who are exposed to different kinds of stressors are no excuse.

According to the latest estimates from World Health Organization, (2017) depression was ranked as a single largest contributor to disability accounting for major contribution to deaths of approximately 800,000 each year. On a worldwide scale, there are more than 300 million people estimated to be living with depression in 2015. Nearly half of all mental health disorders starts at age 14, and most cases are undetected and untreated. The same with adolescents, in which depression also top the rank on the causes of illness and disability and the third is suicide. Violence, poverty, humiliation and feeling devalued can increase the risk of developing mental health problems. The lack of support for people with mental health problems added with stigma prevent many from availing treatments and interventions that they should be getting.

Researchers outlined in the literature those that interfere in seeking help with the professionals of which, one is stigma. Stigma against mental disorders and the fear of being labelled crazy posed barriers against seeking help (Bilican, 2013; Holland & Wheeler, 2016). This fear of mental health stigma is also prevalent among young people (Rickwood, Deane, Wilson, & Ciarrochi, 2005). Stigma is a social construct that refers to a process of social rejection, devaluation and discrimination (Brown et al., 2010) and stigma on mental health is seemingly endorsed by the general public. Once diagnosed with mental illness, many feel overwhelmed by the stigma accompanying the illness (Lloyd, Wong, & Petchkovsky, 2007). These stigmatic views contribute to underutilization of mental health services available.

Public stigma is defined as the "negative stereotypes and prejudice about mental illness held collectively by people in a society or community" while personal stigma is a person's own stigmatizing attitudes about mental health treatment according to Eisenberg et al. (2009).

It can be thought of as a combination of each individual's stereotypes and prejudices. While perceived public stigma is a belief about the attitudes of others to those having mental health problems (Reavley & Jorm, 2011). Previous studies show high levels of public stigma related to mental illness, suggesting that stigma could be a formidable barrier to seeking help. In the long run, perceived public stigma may keep people from accessing mental health services so as to avoid the likelihood of being criticised or discriminated.

Young people in psychologically distress generally prefer the informal help of friends and family before the formal help of medical or psychological professionals (Rickwood et al., 2005) of which a preference for seeking help from "no one" for personal-emotional and suicidal problems is also apparent. The increasing mental health disorders in college students is also growing in terms of degree of severity; however, due to the stigma that accompanies mental health diagnoses and treatments, numerous studies have shown that this population is very hesitant to seek help. Of concern is that the majority of college students with mental disorders, including those at elevated risk for suicidal behavior and suicide, do not receive mental health care (Czyz, Horwitz, Eisenberg, Kramer, & King, 2013)

Enrolling and staying in college is considered to be a major life transition for most students along with pressures, stress, and developing mental health issues. A potential trigger for a mental health symptom exacerbation and development during the transition to college is the high level of stress associated a warning sign for mental health symptoms.

Thus, a need to raise awareness on mental health issues especially for young people is warranted. To do this, the researchers will explore the stigma regarding mental health among college students. Then the measurement of the respondents' help-seeking behaviors through their intention to seek help will be measured. In the end, the researchers shall look into the relationship of stigma and help-seeking behavior to identify possible programs to break the stigma on mental health and enhance college students' awareness for better help-seeking.

## 2. Methodology

### 2.1. Participants

College students from the biggest University in the Province of Tarlac enrolled in S.Y. 2017-2018 participated in this study. Of which, a total of 482 students participated with a mean age of 19.99 years ( $SD = 1.97$ , range = 18-34 years). Of them, 251 were female, 199 were male and the rest did not identify their gender. The respondents were determined by stratified random sampling using Slovin's formula to determine the sample size.

### 2.2. Measures

**Discrimination-Devaluation Scale (D-DS).** Modified perceived discrimination-devaluation scale (D-DS) of Bruce Link and Colleagues and adapted and modified by Eisenberg et al., (2009) was used to measure the level of public stigma. The adapted scale yields Cronbach's  $\alpha = .89$  meaning high in internal reliability. While the measure for level of personal stigma yielded Cronbach's  $\alpha = .78$  which is a relatively high reliability. The respondents answered the perceived and the personal stigma, and to balance out the potential ordering effects of personal and public stigma, the survey questionnaires were randomized.

**General Help-Seeking Questionnaire-Original Scale (GHSQ).** The GHSQ was used to measure the intention to seek help to particular individuals developed by Wilson, Deane, Ciarrochi, & Rickwood, (2005), the instrument intends to compare levels of intentions across help sources and problems. Items were scored in two ways: first, as a single scale that included all specific help source options for suicidal and non-suicidal problems (Cronbach's alpha = .85, test-retest reliability assessed over a three-week period = .92). High scores indicate higher intentions to seek help to a particular help source.

### 2.3. Procedure

Ethical clearance from the Institutional Research Ethics and Review Board and endorsement from the University to conduct the study was secured prior to the invitation of students over the age of 18 to participate voluntarily in this study. Participants were oriented on the purpose of the study and were given two set of questionnaires to measure their levels of stigma and intention to seek help. The data were processed through the aid of IBM SPSS Statistics 20.

### 3. Results

Overall, 482 set of questionnaires were completed a week before the end of the second semester of S.Y. 2017-2018. Table 1 shows that participants reported a mean perceived public stigma score of 2.92 (SD=.32) and a mean personal stigma score of 2.54 (SD=.58), representing a significant difference between perceived public stigma and personal stigma,  $t_{482} = 13.18$ ,  $p < 0.001$ . On average, perceived public stigma score were .38 points higher than those of personal stigma scores. Consistent with the findings of (Hunt & Eisenberg, 2010; Pedersen & Paves, 2014; Reavley & Jorm, 2011) of which in general, other people were perceived as more likely to hold stigmatizing attitudes to those who have mental health problems compared to their own attitudes.

**Table 1.** Levels of Stigma

Sex/ College	<i>n</i>	Perceived Public Stigma (1-5)	SD	Personal Stigma (1-5)	SD
<b>Overall</b>	<b>482</b>	<b>2.92</b>	<b>.32</b>	<b>2.54</b>	<b>.58</b>
Female	252	<b>2.94</b>	.29	2.53	.55
Male	201	2.92	.35	<b>2.57</b>	.59
CAFA	30	2.92	.27	2.47	.68
CASS	31	2.85	.43	2.39	.58
CBA	128	2.93	.25	2.49	.57
CCJE	30	2.90	.26	2.72	.34
CCS	58	3.01	.31	2.69	.59
CET	57	2.86	.35	2.50	.59
COEd	104	2.95	.30	2.55	.54
COS	22	2.89	.38	2.44	.75
CPAG	16	2.99	.51	2.69	.60

*Note: Numbers by gender and college do not sum exactly to the overall N because of missing information (29 students for gender and 6 for college).*

Compared to women, men had slightly lower perceived public stigma (2.92) and slightly higher personal stigma (2.57) - findings that are consistent with those of (Pedersen & Paves, 2014). Comparing the perceived public stigma ( $t_{453} = -.68$ ,  $p > .05$ ) and personal stigma ( $t_{453} = .76$ ,  $p > .05$ ) of males and females, the mean scores of the groups are not significantly different.

Looking at the college to which students belong, students from the College of Arts and Social Sciences (CASS) had the lowest mean perceived public stigma at 2.85 (SD=.43) and those from the College of Computer Studies (CCS) had the highest perceived stigma at 3.01 (SD=.31). As to personal stigma, CASS students had the lowest mean of personal stigma at 2.39 (SD=.58) and the College of Criminal Justice Education (CCJE) students had the highest mean at 2.72 (SD=.34).

**Table 2.** Levels of Help –Seeking

Person intended to seek-help with if having emotional/social	Emotional Personal Problem		Suicidal Thoughts	
	Mean	SD	Mean	SD
Intimate Partner	5.01	1.68	4.77	1.97
Friend	4.40	1.70	4.38	1.80
Parent	5.50	1.71	5.11	2.03
Other Relative/ Family Member	4.75	1.62	4.41	1.82
Mental Health Professional	4.67	1.72	4.70	1.87
Phone Helpline	3.26	1.76	3.24	1.83
Medical Doctor	4.29	1.75	4.22	1.91
Minister/ Religious Leader	4.87	1.74	4.77	1.90
Will not seek help	2.75	1.86	2.83	2.03

Table 2 shows that the participants were more likely to seek help from their parents ( $M=5.50$ ,  $SD=1.71$ ;  $5.11$ ,  $SD=2.03$ ) if they are having emotional or personal problems, and having suicidal thoughts, with the latter having a slightly higher standard deviation. In comparing the participants' intention from whom they would likely seek help, there is a significant difference in seeking help from emotional problem and suicidal thoughts with an intimate partner at  $t_{475} = 2.90$ ,  $p < 0.001$ . On the average, the likelihood to seek help from an intimate partner if having a personal problem is .22 points higher than when experiencing suicidal thoughts. The same comparison is observed in seeking help from a parent ( $t_{476} = 5.01$ ,  $p < 0.001$ ; .39 points) and other relative or family member ( $t_{476} = 4.38$ ,  $p < 0.001$ ; .34 points). Students' help-seeking intentions indicated that students were more willing to seek the informal help of parent and intimate partner than the formal help of professionals with regard to personal-emotional and suicidal problems.

In terms of the relationship of stigma and help-seeking behavior when having a personal or emotional problem, Table 3 discloses that the relationship between participants' perceived public stigma ( $M=2.92$ ,  $SD=.32$ ) and seeking help from intimate partner for personal or emotional problems is a weak positive correlation ( $r=.10$ ) with the use of Pearson's  $r$  data analysis. From this, we could infer that students who scored higher in perceived public stigma registered higher score in seeking help from their intimate partner ( $M=5.01$ ,  $SD=1.68$ ) when having personal or emotional problem. On the other hand, a weak negative correlation ( $r=-.103$ ;  $0.05$ ) existed with regard to seeking help from other relatives which signified that as the participants' perceived public stigma score increase, they are least likely to tell their emotional or personal problems to their other relatives or other family members.

**Table 3.** Correlations of Stigma and help-seeking if having personal or emotional problem

		<i>Public Stigma</i>	<i>Personal Stigma</i>
1.	<b>Intimate Partner</b>	<b>.10*</b>	-.01
2.	Friend	.04	-.03
3.	Parent	-.09	.07
4.	<b>Other Relative/ Family Member</b>	<b>-.10*</b>	<b>.16**</b>
5.	Mental Health Professional	-.06	-.08
6.	Phone Helpline	-.04	<b>.11*</b>
7.	Medical Doctor	.01	.04
8.	Minister or Religious Leader	-.06	.02
9.	I Would not seek help from anyone	-.01	.06

\*\* $p < .01$ , \* $p < .05$ .

Table 3 also shows the correlation of scores between the participants' personal stigma and whom they would seek help for personal or emotional problem. It can be seen from the correlation matrix that there is a weak positive relationship ( $r=.16; .01$ ) concerning seeking help from other relatives. This means that the greater personal stigma score is associated with greater tendency to seek help from other relatives or family members. A weak positive relationship ( $r=.11; 0.05$ ) existed in seeking help via phone helpline. This means that as the participants' personal stigma scores increase, they are more likely to disclose anonymously through phone services. College students also frequently tell others about their mental health problems via social-networking websites --- a medium by which help may be sought informally (Eisenberg, Hunt, & Speer, 2012) and a means by which to access phone helpline.

Table 4 shows the correlation between the participants' public stigma and from whom they would seek help when having suicidal thoughts. It was found out that there is a weak negative correlation ( $r=-.13; 0.01$ ) when it comes to seeking help from other relatives or family members. This means that the higher the public stigma is, the least likely it is to seek help from other relatives and family members.

**Table 4.** Correlations of Stigma and help-seeking if experiencing suicidal thoughts

	<i>Public Stigma</i>	<i>Personal Stigma</i>
1. Intimate Partner	.06	.03
2. Friend	-.01	.05
3. Parent	-.07	.04
4. <b>Other Relative/ Family Member</b>	<b>-.13**</b>	.09
5. Mental Health Professional	-.04	-.06
6. Phone Helpline	-.05	<b>.11*</b>
7. Medical Doctor	-.08	-.01
8. Minister or Religious Leader	-.05	.03
9. I Would not seek help from anyone	.04	<b>.14**</b>

\*\* $p < .01$ , \* $p < .05$ .

Table 4 also shows the correlation between participants' personal stigma and from whom they would seek help when having suicidal thoughts. It can be seen from the correlation matrix that there is a weak positive relationship ( $r=.11; 0.05$ ) in terms of seeking help via phone helpline. This means that as the participants' personal stigma scores increase, they are more likely to disclose anonymously through phone services. In addition, a weak positive correlation ( $r=.144; 0.01$ ) existed between personal stigma and not seeking help. It can be inferred that as the participants' personal stigma scores increase, they are also likely to keep their problems to themselves and not to seek help from others.

## Proposed Mental Health Program

**TSU<sup>for</sup>MH**

Talk Support **U**nite <sup>for</sup> **M**ental **H**ealth

### Talk to Address the Stigma.

Stigma reduction and education initiatives are the most common approaches to increase help seeking behavior in college campuses which Eisenberg et al., (2012) described as something consisting of programs or campaigns to reduce stigma and to educate students as well about mental illness and treatment through facilitation of orientation and advocacy.



The orientation shall disseminate valuable information on mental health to administrators, faculty, personnel, students, parents and family such as those relative to mental health law and measures addressing mental health stigma.

A mental health advocacy shall be promoted through such activities as seminars, posting of print ads and uploading of short video clips via social media and other modes of communication that is accessible to the members of the University Community and other stakeholders.

### **Support by Providing Accessible Services in the Promotion of Well-being**

The availability of Interactive Screening Program shall be made through the Management Information System Office by utilizing a web-based screening tool to identify students with higher risk for suicide and other mental health concerns. It shall be facilitated by qualified university personnel and overseen by the proposed university mental health committee (UMHC).

The College Counselors, with the support of student organizations like the Psychological Society, Peer-Facilitators and the like, shall facilitate activities that enable students to enhance their own well-being.

Seeking help for psychological distress shall be encourage among students by making a Helpline or University Hotline available so then students can talk about their mental health concerns.

### **Unite Formal and Informal Help Sources in and out of the University**

Crisis intervention trainings shall be conducted in response to the mental health needs of the students. One of these is the Gatekeeper-training which involves targeting "gatekeepers"- people who are in frequent contact with others in a community. In this training, gatekeepers shall be provided with skills and knowledge to help them recognize, intervene with, and refer people with mental health crises or potential mental health problems. Eisenberg et al., (2012) identified faculty members, advisers, counselors, or peer leaders as prospective gatekeepers in college campuses. Mental health first aid training for emergency responders, these individuals will be identified by the UMHC and by such outside sources of help as other government mental health services providers, nearest private practitioners.

## **4. DISCUSSION**

This study among randomly selected sample of college students from a university in Tarlac yielded four main findings which are as follows:

(a) the perceived public stigma of students is higher than their personal stigma; (b) the intention of seeking help from informal sources of help is more common than the intention of seeking help from formal sources; (c) perceived public stigma was positively associated with seeking help from an intimate partner and negatively associated with seeking help from other relatives or other family members; and (d) personal stigma was associated with seeking help from other relatives or family members, through phone helpline and not seeking help from anyone.

The first finding suggests that students may have overestimated public stigma on mental health treatment particularly their personal stigma. Just as what was observed through the study of Pedersen & Paves (2014), "social desirability bias, which is a general concern in survey research, may have somewhat been alleviated by the fact that the survey was self-administered. If this bias was behind the difference between reported personal and perceived stigma, such would have by itself been notable, as it would indicate an awareness and response to perceived social norms, at least in words, rather than in actions". This observation was also supported in the study conducted by Hunt & Eisenberg, (2010).

Another major finding of the study is that there is a lower intention to seek help from formal sources instead of asking help from professionals which is the ideal strategy to address mental health concerns. Students are likely to rely on informal sources of help particularly peers, which was also observed by Eisenberg et al., (2012) in a similar study. This also implies another informal route in addressing mental health issues which is by drawing on internal resources like the self as shown from the study of McDermott et al., (2017).

Moreover, the study also found out that perceived public stigma was positively associated with seeking help from an intimate partner in contrast with non-parent family on which a weak negative correlation was found. One of the reasons is that the intimate partner serves as a personal and emotional support thereby encouraging one to express problems.

With regard to the relationship of personal stigma with not seeking help from anyone, the study found out that seeking help from others is a sign of weakness and this goes with the line of thinking that they need to solve their problems on their own. This finding also agrees with the study of Chandrasekara, (2016).

The over-all findings of the present and previous studies of college students' mental health stigma and help-seeking behavior suggest that participants had higher perceived public stigma than personal stigma; there is a likelihood to seek help from informal sources, and that stigma is correlated with help-seeking behavior both positively and negatively.

Drawn from the results of the study are the following recommendations:

(1) Institutionalization of a University Mental Health Committee in order to provide coordinated institutional support concerning mental health issues. This would include initiation of policies to support individuals with mental health difficulties, and promotion of appropriate mental health approaches for a more prepared and informed members of the community – the faculty and staff – in responding to individuals with mental health issues; (2) Institutionalization of a University-Based Mental Health Program to address the mental health needs of students through assessment of risk, intervention and integration of essential student services related to the enhancement of students' well-being. Relative to this, it is important to provide students knowledge in mental health and launch campaign that are vital in reducing the stigma as also recommended by Chandrasekara, (2016); (3) Establishment of a mental health protocol for responding properly to the mental health concerns of students. In addition, an expansion of this research is warranted to include additional demographics and comparisons of clinical and non-clinical samples; and (4) gathering of qualitative samples to establish more comprehensive data on college students' mental health stigma – a step to follow-up and support the limitations of quantitative inquiry on which the study was based.

## References

- Bilican, F. I. (2013). Help-Seeking Attitudes and Behaviors Regarding Mental Health Among Turkish College Students. *International Journal of Mental Health, 42*(2), 43–59. <https://doi.org/10.2753/IMH0020-7411420203>
- Brown, C., Conner, K. O., Copeland, V. C., Grote, N., Beach, S., Battista, D., & Reynolds, C. F. (2010). Depression stigma, race, and treatment seeking behavior and attitudes. *Journal of Community Psychology, 38*(3), 350–368. <https://doi.org/10.1002/jcop.20368>
- Chandrasekara, W. S. (2016). Help Seeking Attitudes and Willingness to Seek Psychological Help: Application of the Theory of Planned Behavior. *International Journal of Management, Accounting & Economics, 3*(4), 233–245.

- Czyz, E. K., Horwitz, A. G., Eisenberg, D., Kramer, A., & King, C. A. (2013). Self-reported Barriers to Professional Help Seeking Among College Students at Elevated Risk for Suicide. *Journal of American College Health, 61*(7), 398–406. <https://doi.org/10.1080/07448481.2013.820731>
- Eisenberg, D., Downs, M. F., Golberstein, E., & Zivin, K. (2009). Stigma and help seeking for mental health among college students. *Medical Care Research and Review, 66*(5), 522–541. <https://doi.org/10.1177/1077558709335173>
- Eisenberg, D., Hunt, J., & Speer, N. (2012). Help seeking for mental health on college campuses: Review of evidence and next steps for research and practice. *Harvard Review of Psychiatry, 20*(4), 222–232. <https://doi.org/10.3109/10673229.2012.712839>
- Holland, D., & Wheeler, H. (2016). Examination of Stigmatic Views on Mental. *Michigan Sociological Review, 30*(Fall), 16–44.
- Hunt, J., & Eisenberg, D. (2010). Mental Health Problems and Help-Seeking Behavior Among College Students. *Journal of Adolescent Health, 46*(1), 3–10. <https://doi.org/10.1016/j.jadohealth.2009.08.008>
- Lloyd, C., Wong, S. R., & Petchkovsky, L. (2007). Art and Recovery in Mental Health: A Qualitative Investigation. *British Journal of Occupational Therapy, 70*(August 2006), 207–214.
- McDermott, R. C., Cheng, H. L., Wong, J., Booth, N., Jones, Z., & Sevig, T. (2017). Hope for Help-Seeking: A Positive Psychology Perspective of Psychological Help-Seeking Intentions  $\phi$ 1/7. *Counseling Psychologist, 45*(2), 237–265. <https://doi.org/10.1177/0011000017693398>
- Pedersen, E. R., & Paves, A. P. (2014). Comparing perceived public stigma and personal stigma of mental health treatment seeking in a young adult sample. *Psychiatry Research, 219*(1), 143–150. <https://doi.org/10.1016/j.psychres.2014.05.017>
- Reavley, N. J., & Jorm, A. F. (2011). Stigmatizing attitudes towards people with mental disorders: Findings from an Australian National Survey of Mental Health Literacy and Stigma. *Australian and New Zealand Journal of Psychiatry, 45*(12), 1086–1093. <https://doi.org/10.3109/00048674.2011.621061>
- Rickwood, D., Deane, F. P., Wilson, C. J., & Ciarrochi, J. V. (2005). Young people ' s help-seeking for mental health problems . *Australian E-Journal for the Advancement of Mental Health, 4*(3), 218–251. <https://doi.org/10.5172/jamh.4.3.218>
- Wilson, C. J., Deane, F. P., Ciarrochi, J. V., & Rickwood, D. (2005). Measuring help seeking intentions: Properties of the General Help-Seeking Questionnaire. *Canadian Journal of Counselling, 39*(1), 15–28. <https://doi.org/10.5172/jamh.4.3.218>
- World Health Organization. (2017). Depression and other common mental disorders: global health estimates. *World Health Organization, 1*–24. <https://doi.org/CC BY-NC-SA 3.0 IGO>

# Segmenting Tarlacqueño-Consumers: An Analysis

Wilmark J. Ramos  
 Department of Marketing Management  
 College of Business and Accountancy-  
 Tarlac State University

**Abstract:** Different approaches have been developed to understand consumers' decision-making styles. One of these is the Consumer Style Inventory (CSI) of Sproles and Kendall (1986). This research was explored to segment Tarlacqueño-consumers' decision-making styles using the CSI approach vis-à-vis their ethnicity through the use of cluster analysis. Data for this report came from a survey of consumers (N = 354) with a structured questionnaire which was distributed to eight shopping malls in Tarlac City. From the three pre-determined ethnicity clusters of Kapampangan, Tagalog, and Ilocano, only two clusters remained. A significant difference between their responses on consumer buying decision making styles was recorded at .000 level.

**Keywords:** *job ethnicity, consumer buying decision making styles, cluster analysis*

## 1. Introduction

The individual buying decision of consumers when choosing between alternative products or services is gradually becoming an issue central to the study of consumer behavior (Sproles and Sproles, 2005). It is believed that consumers engage in shopping with certain fundamental decision-making modes or styles. This phenomenon referred to as consumer decision-making style, have three approaches which focused on the said phenomenon: psychographic / lifestyle, the consumer typology and the consumer characteristics. Psychographic approach is concerned with the decision-making process with respect to the consumers' psychological characteristics and lifestyle; the consumer typology approach puts consumers into general categories in accordance with their shopping styles; while consumer characteristics approach focuses on cognitive and affective orientations specifically related to consumer decision-making. It has identified fundamental consumer decision-making characteristics ranging from rational shopping to impulsiveness.

Sproles and Kendall (1986) integrated the major characteristics of consumer decision making and compiled a comprehensive, unified measurement tool of the mental characteristics of consumer decision making, which was named the Consumer Style Inventory (CSI). The CSI includes eight orientations of consumer decision making: perfectionism/high quality consciousness, brand consciousness/price equals quality, novelty and fashion consciousness, recreational and shopping consciousness, price/value consciousness, impulsiveness/careless, confused by overchoice, and habitual shopping/brand loyal. High quality conscious consumers search carefully and systematically for the highest quality in products while brand conscious people are buying the most expensive and well-known brands. Meanwhile, novelty and fashion conscious customers like new and innovative products for gaining excitement from seeking out new things. They further noted that recreational and shopping conscious individuals consider shopping as a pleasant activity and shops just for the fun of it. Price conscious customers are seeking high value for money; researchers found that impulsive customers never plan their shopping and tend to buy on the spur of the moment. Those confused by over choice customers perceive too many brands and stores and who likely experience information. Lastly, habitual/brand loyal was suggested as another decision making style of consumers who have favorite brands and stores.

Their measurement system built a foundation for a standardized testing of consumer decision making styles and which had been tested, validated, and acknowledged in the international setting.

Evidence from both international and intra-national studies about the pervasive impact of culture on shopping orientations in the cross-cultural context is increasing. In the international context, studies compared Consumer Decision Making Styles (CDMS) among consumers from South Korea and the U.S. (Cho and Workman, 2013); Singapore and Australia (Bennet, and Hartel, 2005); and the U.S., New Zealand, Greece, and India (Lysonski et al., 1996). In the local context, studies compared shopping orientation among subcultures within one country's boundaries. In the U.S., a study that investigated CDMS among Hispanics, Native Americans, and Whites (Shim and Gehrt, 1996) showed distinct shopping orientations for each group, with Hispanics exhibiting a social/hedonic orientation (i.e., brand consciousness, novelty and fashion consciousness, recreational shopping, and brand loyalty), Native Americans showed an overpowered orientation (i.e., impulsive and confused by over-choice), and Whites, a utilitarian orientation (i.e., quality and price consciousness). These studies show that while CDMS exhibit a consistent pattern of cognitive and affective consumer responses, differences in shopping orientations exist among groups that are culturally distinct. In fact, according to De Mooij and Hofstede (2011), CDMS is one of the mental processes that are influenced by culture and which later on are translated into various consumer behavior domains.

Another important element of culture is the consumers' ethnicity. It is defined as a primary sense of belonging to an ethnolinguistic group, which is consanguineal in nature in the sense that the ties are reckoned by blood and traced through family tree (PSA, 2016a). In the Philippines, ethnic grouping denotes genealogical, paternal as well as maternal lineage to any of the country's group of native population (PSA, 2016b). The Philippines has a total of 182 ethnolinguistic groups; around 110 of which are considered as indigenous people (IP) groups.

Tarlac is a landlocked province of the Philippines located in the Central Luzon which borders Pampanga to the south, Nueva Ecija to the east, Pangasinan to the north, and Zambales to the west, thereby making the province as "The Melting Pot." Kapampangan is spoken by more than half of the population followed by Ilocano spoken by 41%. Filipino is widely understood (<https://tarlacprovince.wordpress.com/about/>). Four ethnic groups reside in the province: the Kapampangans, Tagalog, Ilocano, and Pangasinense.

In reality, a culturally diverse market requires business leaders and marketers to acquire practical understanding of consumer behavior. This led the researcher to explore the study on ethnicity and the buying decision making styles of Tarlacqueño consumers.

## **2. Objectives of the study**

1. To segment Tarlacqueño consumers' ethnicity and their buying decision making styles.
2. To provide implications of results in the field of business.

Hypothesis: There is no significant difference between the decision making styles of ethnicity clusters.

## **3. Methodology**

This research was undertaken to identify the buying decision-making styles of Tarlacqueño consumers and to find out the differences in response among the three ethnic groups, namely Kapampangan, Tagalog, and Ilocano.

A self-administered questionnaire was employed to gather data for this study, which consisted of Sproles and Kendall's (1986) 29-item Likert Scaled Consumer Style Inventory (CSI); demographic questions and more importantly, the ethnic group where respondents belong to was also included.

The total number of questionnaires distributed and returned was four hundred (400) of which three hundred and fifty-four (354) were usable for data analysis. There were eight (8) shopping malls identified within Tarlac City, namely: SM City Tarlac, My Metrotown Mall, Magic Star, Citywalk, Citi Mall, Palm Plaza, C&S Shopping Complex, and The Market City. Participation was voluntary and no incentives were offered to any respondent's participation. A mall-intercept data collection method was used by the research as it is one of the most widely accepted marketing research data collection/sampling methods.

The study made use of K-means cluster which is a method to quickly cluster large data sets. The researcher defined the number of clusters in advance. This is useful to test different models with a different assumed number of clusters. At the same time, a two-step cluster analysis was utilized that identifies groupings by running pre-clustering first and then by running hierarchical methods. K-means and two-step cluster analyses were the primary statistical tool used for the data collected. For the respondents' demographic profile, frequency and percentage were used.

The respondents' ages ranged from 21-37 years with 45.7% of the total population of which 47.2% were Kapampangans; this was followed by the age bracket of 20 and below having 41.2% representation. Majority (63.8%) were females of which 50.8% combination of Tagalogs and Ilocanos, while males accounted for 29.8% and the remaining 6.4% claimed to be part of the Lesbian, Gay, Bisexual, and Transgender (LGBT) community or the third sex. More than half (56.4%) of the respondents were students (high school to graduate school) and 30.5% were employees both from public and private sectors.

Table 1. Summary of Respondents' Profile

Profile Variables		Ethnicity						
		Kap		Tag		Ilo		
		F	%	F	%	F	%	
<b>Age Group</b>	20 and below	69	41.6	61	46.9	16	27.6	146
	21-37 y/o	77	46.4	53	40.8	32	55.2	162
	38-53 y/o	15	9	12	9.2	10	17.2	37
	54-72 y/o	5	3	4	3.1	-	-	9
	<b>Total</b>	<b>166</b>	<b>100</b>	<b>130</b>	<b>100</b>	<b>58</b>	<b>100</b>	<b>354</b>
<b>Gender</b>	Male	42	25.3	45	34.6	18	31	105
	Female	111	66.9	77	59.2	38	65.5	226
	LGBT	13	7.8	8	6.2	2	3.4	23
	<b>Total</b>	<b>166</b>	<b>100</b>	<b>130</b>	<b>100</b>	<b>58</b>	<b>100</b>	<b>354</b>
<b>Occupation</b>	Student	106	63.9	63	48.5	31	53.4	200
	Private Employee	9	5.4	16	12.3	11	19	36
	Government Employee	36	21.7	27	20.8	9	15.5	72
	Unemployed	15	9	24	18.5	7	12.1	46
	<b>Total</b>	<b>166</b>	<b>100</b>	<b>130</b>	<b>100</b>	<b>58</b>	<b>100</b>	<b>354</b>
<b>District of Residence</b>	1	11	6.6	29	22.3	27	46.6	67
	2	88	53	71	54.6	23	39.7	182
	3	67	40.4	30	23.1	8	13.8	105
	<b>Total</b>	<b>166</b>	<b>100</b>	<b>130</b>	<b>100</b>	<b>58</b>	<b>100</b>	<b>354</b>

Majority (51.4%) of the respondents hailed from the 2<sup>nd</sup> district of Tarlac (mostly were from Gerona, and Tarlac City); 29.7% were from the 3<sup>rd</sup> district (majority mentioned Capas, Concepcion, and La Paz), and 19% of them originated from the 1<sup>st</sup> district (mostly from Camiling, Moncada, Panniqui, and Sta. Ignacia).

Across the different ethnic groups, respondents categorized themselves as belonging to the Kapampangan (46.9%); Tagalog (36.7%), and Ilocano (16.4%).

#### 4. Results and Discussions

The data set was carried out through the k-means and two-stage cluster analysis.

**Table 2.** Results of the Cluster Analysis

Cluster	1	2
Size	46.9% (166)	53.1% (188)
Consumer Decision Making Styles	Kapampangan	Tagalog (69.1%) / Ilocano
Brand conscious	3.27	3.38
Recreational- hedonistic	3.26	3.29
Confused by overchoice	3.41	3.49
Novelty- fashion	3.20	3.29
Quality conscious	3.56	3.71
Shopping avoidance	3.25	3.24
Price conscious	3.40	3.58
Impulsive-careless	3.43	3.46

The table represents the results of the cluster analysis procedure employing the SPSS software. Based on the ethnic group homogeneity and distance measure between cluster combinations, only two (2) were retained from the three (3) pre-determined clusters of ethnic groups: these are cluster 1 (Kapampangan); and cluster 2 (Tagalog and Ilocano, combined).

#### Cluster 1 (46.9% of the sample): Kapampangans.

This segment contained 166 members. This market segment might be best described as quality conscious, impulsive-careless, and confused by overchoice. They are particular to the quality of products and services they purchase.

Premised on this result, according to Tangingco (2013), Kapampangans call themselves conceited who sincerely believe that they are the best and the most in everything. Moreover, they love a good life; they cannot last a week without going to malls where they can find a way for spending their savings. In search of products/services with the highest and best form of quality, they tend to be confused with the wide array of choices available in the marketplace, both in the traditional store and online.

Majority of respondents were part of the generation Y (also known as the millennial generation) and generation Z (sometimes referred to as extension of generation Y); these people live with a highly sophisticated media and technology. It enables the respondents to reach the products and services of their choice 24 hours a day, 7 days a week.

According to Simões and Gouveia (2008), having used technologies since childhood, most of millennials have become accustomed to depending on their laptops, cell phones, instant messaging, e-mail, the web, and interactive media in almost all aspects of their lives. This lifestyle influences the patterns of consumption that are typical of this generation. However, with the variety and assortment product and service comes confusion among Kapampangan-respondents. They often tend to feel confused because of so many brands to choose from.

Eventually, this may result to impulsive and careless choice among respondents. Koski (2004) stated that impulse purchasing is affected by several factors such as easy accessibility of store, wider range of goods, promotional activities; while Kacen and Lee (2002) specified several factors affect the impulse behavior; consumers' moods and affective states, gender, age, consumers' normative evaluation and culture.

From among the 354 respondents, Kapampangan females accounted to 111 or 31.3%. This significant number may be attributed to the consumer decision making style of being impulsive-careless. Several studies have already investigated gender difference on buying behavior and have shown significant results, such as Isler and Atilla (2013), Tifferet and Herstein (2012), and Coley and Bergess (2003) to name a few.

### **Cluster 2 (53.1% of the sample): Tagalog-Ilocano.**

This cluster was comprised of 188 members of whom 69.1% or 130 belonged to Tagalogs. This segment indicated that they are quality conscious, price conscious, and confused by overchoice. According to studies, the Tagalog culture is considered to be the most westernized of all Filipino ethnic groups. It was influenced by multiple international cultures particularly the American, Spanish and Chinese cultural traditions. Ilocanos, on the other hand, make up the Philippines largest ethnic group; they represent about 9% on the national population and were believed to be descended from the Malay race. Overtime, the Ilocanos have had significant mixing with other groups like the Chinese, Indians and Spanish people (Defense Language Institute Foreign Language Center, 2014).

"Quality conscious" and "confused by overchoice" consumer decision making style of Tagalog-Ilocano respondents were the same with that of the Kapampangan respondents. However, data analysis showed that they are price-conscious. According to an online article (<http://www.everyculture.com/wc/NorwaytoRussia/Ilocano.html>), one of the admirable traits of Ilocanos is being frugal towards money. It has become an ingrained aspect for most of them that they are automatically stereotyped as tightfisted. This generalization has manifested on the cluster results with "price conscious" as one of the highest buying decision making styles. According to respondents, being frugal takes into account the best choice of products from among the available and making the most of out the hard-earned money by means of quality products that are durable that last long. This finding supports the above stated article.

In addition, Tagalogs (being the most westernized among the Filipino ethnic groups) were also conscious to the price and to buying quality products. Just like the western-mentality on price-quality relationship, it does not really matter if the price is high, because for them, consumers need to pay the price for quality.

On the next table are the cluster's anova results. The purpose of the test was to ensure whether significant differences exist between the two ethnic clusters identified in this study. Hence, the stated hypothesis could either be rejected or accepted.



**Table 3.** ANOVA Cluster Results

	Cluster		Error		F	Sig.
	Mean Square	df	Mean Square	df		
BC	18.740	1	.285	352	65.757	.000
REC	4.389	1	.233	352	18.734	.000
CONF	24.523	1	.317	352	77.392	.000
NOV	39.215	1	.377	352	103.976	.000
QC	29.987	1	.294	352	102.069	.000
SAV	22.275	1	.534	352	41.740	.000
PC	15.493	1	.435	352	35.585	.000
IMP	27.045	1	.426	352	63.493	.000

*The F tests should be used only for descriptive purposes because the clusters have been chosen to maximize the differences among cases in different clusters. The observed significance levels are not corrected for this and thus cannot be interpreted as tests of the hypothesis that the cluster means are equal.*

### 5. Implications

The table has shown that all the consumer buying decision making styles (namely, Brand conscious, Recreational- hedonic, Confused by overchoice, Novelty-fashion seeking, Quality conscious, Shopping Avoidance, Price Conscious and, Impulsive-careless) between the two clusters were recorded at .000 significance level. Rejecting the null hypothesis, it is therefore confirmed that there is a significant difference between the two clusters: Kapampangan and Tagalog-Ilocano.

This pilot research on clustering of ethnicity and buying decision making styles of Tarlacqueño consumers was geared to profile and segment the local market. However, limitations restrict the researcher to generalize the findings, for the following reasons: first, the study was only focused to the three ethnic groups present in Tarlac while the distribution was conducted in shopping malls during the peak season (November 2017- January 2018). Therefore, further studies are needed to analyze and treat specifically with different populations, including off/lean seasons of shopping mall operations. Obtaining different results may be possible if the data were collected from towns/municipalities identified with majority of its population belonging to specific ethnic groups (i.e. Concepcion for Kapampangan; Camiling for Ilocanos). Second, the study did not factor in other demographic variables like age, civil status and gender in the clustering analysis which could also provide equally interesting results. Thus, it could be suggested that in future research, these variables could be explored. Furthermore, this study could extend to investigate the consumer decision making styles in considering specific product class/category or for domestic/foreign products. Replication of this study without regard to ethnicity could also be considered.

The results of the reviewed research point out the relevance of the concept of ethnicity to consumer buying decision making styles, thereby underscore some implications for business managers and marketers. The finding may also help researchers and educators understand more clearly about Tarlacqueño consumers' with respect to ethnic differences as well as their similarities to decision making styles.

They should make the consumers of varying ethnicity believe and recognize the promise of their products to offer quality with a reasonable price. As a result, consumers may develop some kind of relationship with the local business enterprise, which will in turn influence their purchase behavior. When business are able to determine the factors driving purchase decisions, they will be able to better tailor fit market offering and other marketing strategies to the needs and wants of Tarlacqueño local market.

## 6. Acknowledgement

The researcher would like to extend his sincerest gratitude to Prof. Chris Mark V. Catalan, who untiringly shared his expertise in statistics and Ms. Maria Sheila Garcia-Medina who gave valuable inputs in this research

## References

- Cho, S., and J. E. Workman. 2013. Shopping orientations of young South Korean and U.S. Consumers. *Journal of International Consumer Marketing* 25: 319–331.
- Coley, A. and Burgess, B. (2003) Gender differences in cognitive and affective impulse buying. *Journal of Fashion Marketing and Management: An International Journal*, Vol. 7 Issue: 3, pp.282-295, <https://doi.org/10.1108/13612020310484834>
- Defense Language Institute Foreign Language Center (DFIFLC, 2014). Ilocano Cultural Orientation.
- De Mooij, M., and G. Hofstede. 2011. Cross-cultural consumer behavior: A review of research findings. *Journal of International Consumer Marketing* 23 (3–4): 181–192.
- Kacen, J. J., & Lee, J. A. (2002), “The Influence of Culture on Consumer Impulsive Buying Behavior”, *Journal of Consumer Psychology*, Vol. 12 No.2, 163-176
- Koski, N. (2004), “Impulse Buying on the Internet: Encouraging and Discouraging Factors”, *Frontiers of E-Business Research*, University of Tampere, September 20-22, 21-34
- Leo, C., Bennett, R. and C. E. J. Hartel. (2005). Cross cultural differences in consumer decision-making styles. *Cross Cultural Management* 12 (3): 32–62.
- Lysonski, S., S. Durvasula, and Y. Zotos. 1996. Consumer decision-making styles: A multi-country investigation. *European Journal of Marketing* 30 (12): 10–21.
- Philippine Statistics Authority. 2016a. Philippines – Census of Population and Housing 2000, 10% sample. PSADataArchive. <http://web0.psa.gov.ph/psada/index.php/catalog/54>
- Philippine Statistics Authority. 2016b. 2010 Census of Population and Housing: Definition of terms and concepts [www.census.gov.ph/sites/default/files/attachments/hsd/Explanatory%20Text.pdf](http://www.census.gov.ph/sites/default/files/attachments/hsd/Explanatory%20Text.pdf)
- Shim, S., and K. C. Gehrt. 1996. Hispanic and Native American adolescents: An exploratory study of their approach to shopping. *Journal of Retailing* 72 (3): 307–324.
- Simões, L. e Gouveia, L. (2008). Consumer Behaviour of the Millennial Generation. III Jornadas de Publicidade e Comunicação. A Publicidade para o consumidor do Séc. XXI. UFP. Porto. 10 de Abril.
- Sporles, E.K., Sproles, G..B. (2005), Consumer Decision-Making Styles as a Function of Individual Learning Styles. *Journal of Consumer Affairs*, 24(1), 134-147.

Tantingco, R. (2013). 10 Things You Need to Know About Kapampangans. First Published in Sunstar. July 30, 2013. <http://www.sunstar.com.ph/article/296907/Tantingco-10-Things-You-Need-to-Know-About-Kapampangans>

Tifferet, S. and Herstein, R. (2012). Gender differences in brand commitment, impulse buying, and hedonic consumption", Journal of Product & Brand Management, Vol. 21 Issue: 3, pp.176-182, <https://doi.org/10.1108/10610421211228793>

**Online Sources: .**

<https://tarlacprovince.wordpress.com/about/>

<http://www.everyculture.com/wc/NorwaytoRussia/Ilocano.html>

# Development of integrated Administrative Management System: Procurement Module for Tarlac State University

Heidilyn V. Gamido and Marlon V. Gamido

College of Computer Studies

Tarlac State University

**Abstract:** The paper discussed the development of the integrated Management System: Procurement Module of Tarlac State University, which aimed to make the procurement process efficient. The Procurement Module of the system includes the creation and consolidation of the PPMP, automated generation of the APP and management and monitoring of the procurement activities. The system enables the users a web-based creation and submission of the PPMP up to automatic consolidation of evaluated items for the preparation of the APP. The system was also evaluated as Outstanding by the users and IT experts because of the increased in the work efficiency of Procurement Unit due to timely submission of the APP and better monitoring of the procurement activities which resulted to greater customer satisfaction.

**Keywords:** *APP; procurement; PPMP; purchasing*

## 1. Introduction

State Universities and Colleges (SUCs) are public institutions of higher learning that were created by an Act passed by the Congress of the Philippines (PIDS, 2015). These institutions are fully subsidized by the national government and may be considered as a corporate body. Since SUCs are government entities, all their resources shall be managed, expended or utilized in accordance with the law and regulation, safeguard against loss or wastage through illegal or improper disposition, with a view to ensuring economy, efficiency and effectiveness in operation of the government.

One of the most common operations among SUCs and other government agencies is their procurement and property management. Procurement is defined as the process by which organizations define their needs for goods and services, identify and compare the suppliers and supplies available to them, negotiate with sources of supply or in some way arrive at agreed terms of trading, make contracts and place orders, and finally receive the goods and services and pay for them (Baily, 1987).

Procurement activities should conform to rules set by Republic Act 9184 known as the "Government Procurement Reform Act," which provides the modernization, standardization, and regulation of the procurement activities of all government institutions (Official Gazette, 2016). All items to be bought by an SUC should be classified and be posted at PhilGEPS.

The Procurement Unit of Tarlac State University has the primary function to ensure that the university procures the highest quality of supplies, materials, and equipment with the minimum expense to the government. It also aims to ensure the availability of materials/goods when needed by the end-user.

Procurement planning is the first step in the procurement process. Procurement planning consists of the submission of the Project Procurement Management Plan (PPMP), which refers to the itemized list prepared by the head of each unit and offices. Afterward, there is an evaluation and consolidation of these PPMPs to the Agency Annual Procurement Plan (APP). The APP is the required document that the agency must prepare to reflect the necessary information on the entire procurement activities that the agency plans to undertake within a calendar year.

At present, offices at TSU submit a hardcopy of PPMP to Procurement Unit. A committee then evaluates the submitted PPMP forms while the staff of the Unit manually consolidates all evaluated items from PPMP to APP using a spreadsheet. Due to numerous item requests with various descriptions and requirements, the Procurement Unit cannot efficiently perform its task in creating an accurate APP thus affecting the whole procurement process. Problems arise like duplication of items, wrong tagging of the category, non-inclusion to the consolidated APP. Also, the requesting office cannot monitor the items requested whether it was approved or not which usually leads to duplication of their request from the previous year.

The research aims to help the Procurement Office in automating the consolidation of PPMP to APP for proper evaluation and monitoring. Likewise, the proposal will also ease the preparation of the documents/forms needed for procurement since they no longer need to input the same information for different forms. The research can be used as a benchmark for other SUCs in developing their tools for their procurement process.

## **2. Objectives of the Study**

The research aimed to develop an online Procurement Module of the integrated Administrative Management System (iAMS) for Tarlac State University that will improve the procurement process. Specifically, the research aimed to achieve the following objectives:

1. To develop a system to be used by the Procurement Office with the following features:
  - a. Creation and evaluation of Project Procurement Management Plan of offices;
  - b. Generation of the Annual Procurement Plan;
  - c. Identification of procurement mode for APP;
  - d. Management and monitoring of procurement activities
2. To evaluate the developed system by:
  - a. Users
    - a.1. Functional suitability;
    - a.2. Performance efficiency;
    - a.3. Usability;
    - a.4. Reliability
  - b. IT Experts
    - b.1. Security;
    - b.2. Maintainability;
    - b.3. Portability

## **3. Methodology**

The study used Development design to undertake the study. It used Scrum Agile methodology in software development since this methodology easily adapts to changes, and able to work side by side with end-users to make necessary adjustments when specific requirements are altered (Matharu, 2015).

The research started with a vision, meeting the product owners to discuss the initial expectations. During the meeting, the scope, milestone, and deliverables were agreed upon. The identification of functional requirements of the system were then identified and ordered accordingly based from priority. The next stage was system development process which was done in sprints. Each sprint consists of two weeks, depending on the complexity of the functions and project backlog. Fig. 1 illustrates the steps using the Scrum methodology.

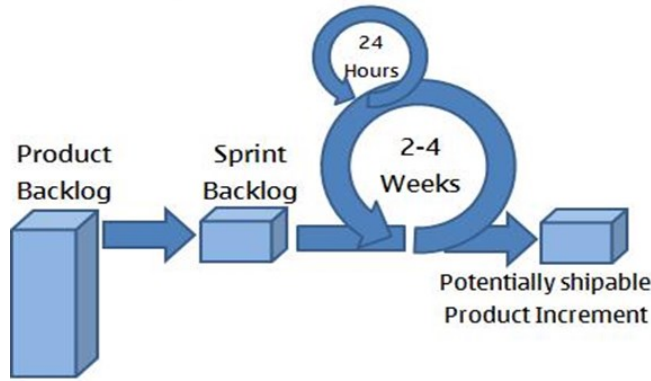

**Figure 1.** Agile Scrum Methodology

The system was developed using Visual Studio 2015 Framework, ASP.Net, C#, SQL Server 2016 for database and Crystal Report 13.

Respondents of the study were the staff from the Procurement Unit and requesting officers who have access to the system and three IT experts evaluated the system. Likert’s scale was used to interpret the result of the evaluation.

**4. Results and Discussion**

4.1. To develop a system to be used by the Procurement Office with the following features:

- a. Creation and evaluation of Project Procurement Management Plan of offices;

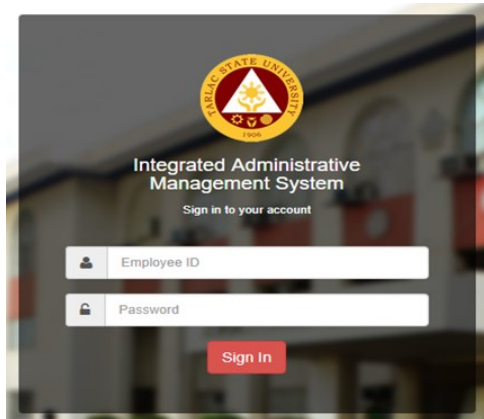

**Figure 2.** Home Screen

Fig. 2 shows the home screen of the developed system which is accessible by accessing the URL [iams.tsu.edu.ph](https://iams.tsu.edu.ph). The https appears in the URL because the website is secured with an SSL certificate. Fig. 3 below shows the menu for the Procurement Module.

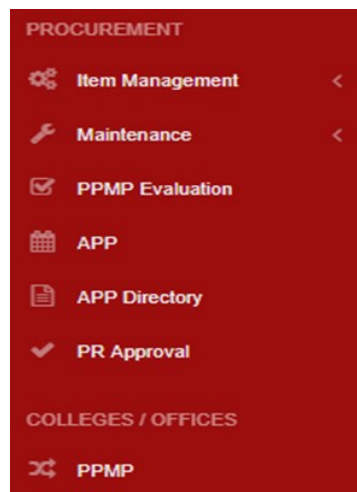

**Figure 3.** Procurement Module

To create a PPMP, the requesting officer of the college or office needs to search the items needed to be purchased together with the quantity needed per quarter, as seen in Fig. 4. If the item is not available on the list, the requesting officer needs to inform the Procurement Unit so that the item will be included in the item list. Item management eliminated duplication of items because each item has its own item id.

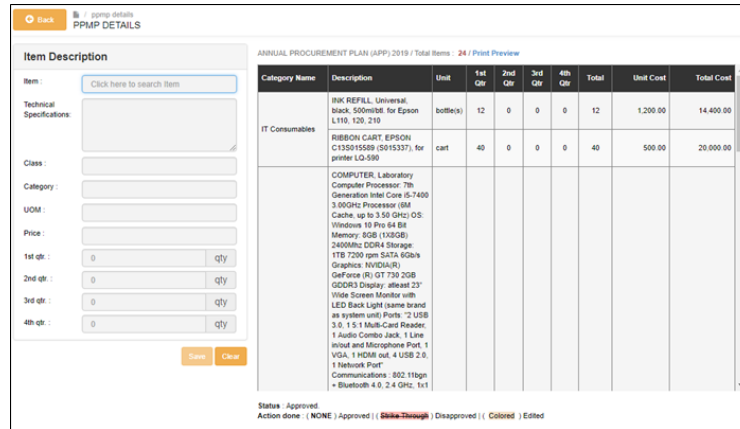

Figure 4. PPMP Details

Category	Description	Unit	1st Qtr	2nd Qtr	3rd Qtr	4th Qtr	Total	Unit Cost	Total Cost	Status	
PS-Common Use Supplies	MARKER, permanent, bullet type red, 12 pieces/box	piece(s)	4	0	0	0	4	9.85	38.60	Approved	
	MARKER, whiteboard, bullet type red, 12 pieces/box	piece(s)	4	0	0	0	4	10.31	41.24	Approved	
	MARKING PEN, whiteboard, black	piece(s)	8	0	0	0	8	25.00	200.00	Approved	
	PIPER CLIP, gem type, 32mm, 100 pieces per box or 52 grams (min.) (net of box) 50 boxes/carton	box	6	0	0	0	6	5.98	35.88	Approved	
	PIPER CLIP, gem type, 48mm, 100 pieces per box or 120 grams (min.) (net of box) 50 boxes/carton	box	6	0	0	0	6	12.74	76.44	Approved	
	PIPER, Multi-Purpose A4, 70gsm, 5 reams/box	ream(s)	6	0	0	0	6	104.16	624.96	Approved	
	PIPER, Multi-Purpose Legal, 70 gsm, 5 reams/box	ream(s)	24	0	0	0	24	118.35	2,840.40	Approved	
	PUNCHER, heavy duty	piece(s)	2	0	0	0	2	131.96	263.92	Approved	
	STAMP PAD, ink, 50ml. (min.) 12 bottles/box	bottle(s)	1	0	0	0	1	24.63	24.63	Approved	
	STAPLE WIRE, standard 100 boxes/carton	box	4	0	0	0	4	20.68	82.72	Approved	
	TAPE, masking, 24mm, width: 24mm, 12 rolls/box	roll	2	0	0	0	2	55.12	110.24	Approved	
	TAPE, masking, 48mm, width: 48mm, 6 rolls/box	roll	2	0	0	0	2	106.60	213.20	Approved	
	TAPE, transparent, 24mm, width: 24mm, 6 rolls/box	roll	4	0	0	0	4	9.10	36.40	Approved	
	TAPE, transparent, 48mm, width: 48mm, 6 rolls/box	roll	2	0	0	0	2	18.20	36.40	Approved	
	Accommodation	SEMINARS, vgsa, planning	lot	0	0	1	0	1	200000.00	200,000.00	Approved
Services	MEETING	CATERING, Academic Council Meeting (4 meetings)	peak	244	0	244	0	668	600.00	66,800.00	Disapproved
	MEETING	CATERING, Meals for meetings (Council of Deans and Academic Directors, FSB, Committee Meetings, Emergency Meetings)	peak	300	0	300	0	600	600.00	60,000.00	Disapproved

Total: 282,327.33  
 Legend: ● = Approved ● = Disapproved ● = Pending  
 NOTE: This record was already approved for consolidation

Figure 5. Evaluated PPMP

Fig. 5 showed the evaluated and approved PPMP of the requesting office. The final PPMP shows the status of the item requested, whether it was approved or disapproved and the total amount of allocated for the PPMP of the office.

b. Generation of the Annual Procurement Plan;

Once the evaluation of the PPMP is done, and the APP settings have been added, the system will notify the Procurement Unit on the total number of PPMP records included in the APP.



Figure 6. APP Notification

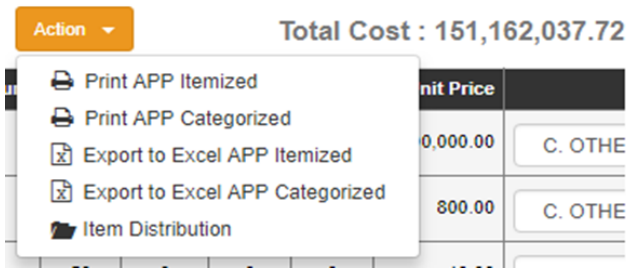

Figure 7. APP report

The system will automatically merge all requested items to produce the APP of the University. The system will also automatically sum up the total cost of the APP. Furthermore, the APP report can be viewed and printed by item, category or item distribution. Figure 8 shows a sample of the consolidated APP which has a total of 83 pages.

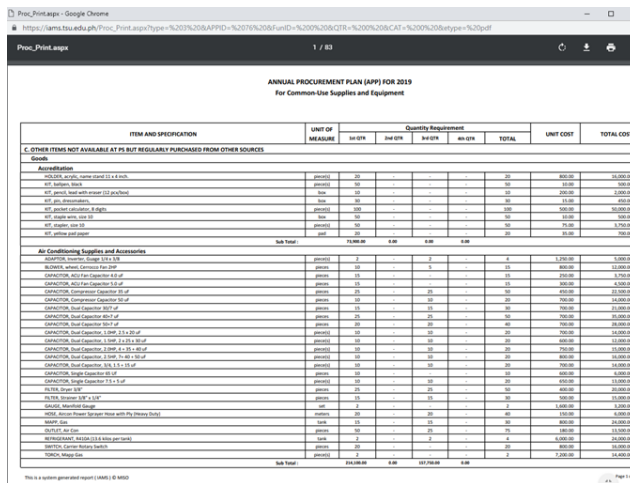

Figure 8. Sample APP report

c. Identification of procurement mode for APP;

Unit of Measure	1st Qtr	2nd Qtr	3rd Qtr	4th Qtr	Unit Price	Tag Items
lot	1	0	0	0	1,500,000.00	C. OTHER ITEMS NOT AVA
piec	A. DIRECT CONTRACTING B. AVAILABLE AT PROCUREMENT SERVICE STORES C. OTHER ITEMS NOT AVAILABLE AT PS BUT REGULARLY PURCHASED FROM OTHER SOURCES					

Figure 9. Procurement mode

All items in the APP will then be tagged whether the item is for direct contracting, whether the item is available or not at the Procurement Service Store.

Figs. 10 and 11 show the purchase request form of the items identified under a procurement mode.

PURCHASE REQUEST Tarlac State University Agency					
Department: Various Offices		PR No.: 2017-06-00185		Date: 06/23/2017	
Section:		SAI No.: 00143-17		Date: 05/04/2017	
ITEM NO.	Unit of Measure	ITEM DESCRIPTION	QTY	UNIT COST	TOTAL COST
<b>B. AVAILABLE AT PROCUREMENT SERVICE STORES</b>					
<b>Goods</b>					
<b>Grocery Items</b>					
45438	pack	BATTERY, Size D, 2 pieces per blister pack	16	300.00	4,800.00
			Subtotal:		4,800.00
<b>Office Supplies</b>					
45262	box	CHALK, white, dustless, 100 pieces per box	57	70.00	3,990.00
47638	box	INDEX TAB, Self-adhesive, 5 sets/box, assorted colors	98	90.00	8,820.00
			Subtotal:		12,810.00
<b>PS-Common Use Supplies</b>					
47928	roll	ACETATE, Gauge #3, 50m per roll	7	700.00	4,900.00
45435	pack	BATTERY, size AA, 2 pieces per blister pack	10	60.00	600.00
45436	pack	BATTERY, size AAA, 2 pieces per blister pack	8	30.00	240.00
46251	tube	BLADE, Heavy duty cutter, 10 pcs./tube	3	60.00	180.00
47645	box	CLIP, backfold, 19mm, 12 pieces per box 50 boxes/carton	22	25.00	550.00
45264	box	CLIP, backfold, 25mm, 12 pieces per box 50 boxes/carton	24	40.00	960.00
47577	box	CLIP, backfold, 32mm, 12 pieces per box 50 boxes/carton	8	50.00	400.00
45268	box	CLIP, backfold, 50mm, 12 pieces per box 50 boxes/carton	17	70.00	1,190.00
47567	piece(s)	CORRECTION TAPE, disposable, usable length of 6 meters (min), 5mm	109	40.00	4,360.00

Figure 10. Items available at PS



PURCHASE REQUEST Tarlac State University Agency					
Department: Various Offices		PR No.: 2017-06-00184	Date: 06/23/2017		
Section:		SAI No.: 00143-17	Date: 05/04/2017		
ITEM NO.	Unit of Measure	ITEM DESCRIPTION	QTY	UNIT COST	TOTAL COST
<b>C. OTHER ITEMS NOT AVAILABLE AT PS BUT REGULARLY PURCHASED FROM OTHER SOURCES</b>					
<b>Goods</b>					
<b>IT Consumables</b>					
46250	bottle(s)	INK CART, EPSON L210/L120/L565 (70ml) Black	9	350.00	3,150.00
45416	cartridge	INK CART, EPSON, M100/M200, Black, Original	10	700.00	7,000.00
47752	cartridge	INK CART, HP 478 (C2107AA), black, Original	3	450.00	1,350.00
47754	cartridge	INK CART, HP 478 (C2108AA), tri-color, Original	3	480.00	1,440.00
48593	bottle(s)	INK REFILL, Universal, black, 500ml/btl, for Epson L110, L20, L210	5	1,200.00	6,000.00
46274	piece(s)	RIBBON CART, Refill, EPSON LQ 590	75	45.00	3,375.00
46034	cart	TONER CART, HP 95A LaserJet, black, for printers P2035, 2055, Original	3	4,000.00	12,000.00
45716	cartridge	TONER CART, HP 128A LaserJet, Black, for printers CM1415, CP1525, Original	1	3,500.00	3,500.00
46247	cart	TONER CART, HP 128A LaserJet, Cyan, for printers CM1415, CP1525, Original	1	3,500.00	3,500.00
46248	cart	TONER CART, HP 128A LaserJet, Magenta, for printers CM1415, CP1525, Original	1	3,500.00	3,500.00
46249	cart	TONER CART, HP 128A LaserJet, Yellow, for printers CM1415, CP1525, Original	1	3,500.00	3,500.00
45720	cartridge	TONER CART, HP 35A LaserJet, Black, for printers P1105, 1006, Original	7	3,500.00	24,500.00
46246	cart	TONER CART, HP 85A LaserJet, Black, for printers P1102, P1102w, M1132, M1212, M1214, M1217, Original	80	3,500.00	280,000.00
Subtotal:					<b>352,815.00</b>
Grandtotal:					<b>352,815.00</b>

Figure 11. Items not available at PS

d. Management and monitoring of procurement activities

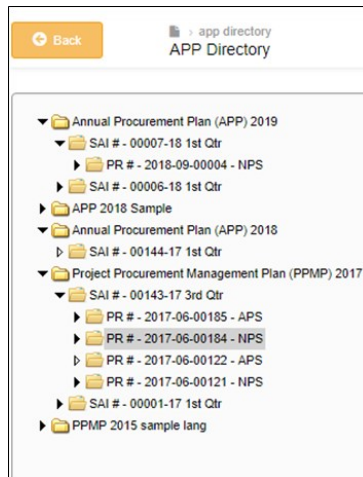

Figure 12. APP Directory

Fig 12 shows the Supply Availability Inventory and Purchase Request forms created in a particular APP. The SAI and PR number are based on the year, quarter, month and procurement mode.

The screenshot shows the 'SAI status' interface. At the top, there are three status indicators: 'Unposted' (green circle), 'Posted' (green circle), and 'Supply' (yellow circle). Below this is a table with columns: Item No., Category, Technical Specifications, Unit, Total, Unit Cost, and Total Cost. The table lists various items such as 'KIT, balpen, black', 'KIT, pencil, lead with eraser', 'KIT, yellow pad paper', etc. Below the table, there is a 'Manage PR' section with a dropdown menu and another table showing details for a selected PR (49302).

Item No.	Category	Technical Specifications	Unit	Total	Unit Cost	Total Cost
50522	Accreditation	KIT, balpen, black	piece(s)	50	10.00	500.00
50523	Accreditation	KIT, pencil, lead with eraser (12 pc/box)	box	5	200.00	1,000.00
50524	Accreditation	KIT, yellow pad paper	pad	20	35.00	700.00
50525	Accreditation	KIT, stapler, size 10	piece(s)	50	75.00	3,750.00
50526	Accreditation	KIT, staple wire, size 10	box	50	10.00	500.00
50545	Accreditation	KIT, pocket calculator, 8 digits	piece(s)	50	500.00	25,000.00
50600	Accreditation	KIT, pin, dressmakers	box	50	15.00	750.00
49302	Air Conditioning Supplies and Accessories	BULB, ACU Access Bulb	pieces	50	55.00	2,750.00
49303	Air Conditioning Supplies and Accessories	CAPACITOR, ACU Fan Capacitor 4.0 uF	pieces	10	195.00	1,950.00
49304	Air Conditioning Supplies and Accessories	CAPACITOR, ACU Fan Capacitor 5.0 uF	pieces	10	230.00	2,300.00
49305	Air Conditioning Supplies and Accessories	ADAPTOR, for R404	piece(s)	2	650.00	1,300.00
49307	Air Conditioning Supplies and Accessories	HOSE, Arcan Power Sprayer Hose with Ply (Heavy Duty)	meters	2	1,200.00	2,400.00

Figure 13. SAI status

Fig. 13 shows the status of the SAI. A yellow status means that the SAI is still in the Accounting office for verification of stocks availability. The status is changed to green when it has been verified.

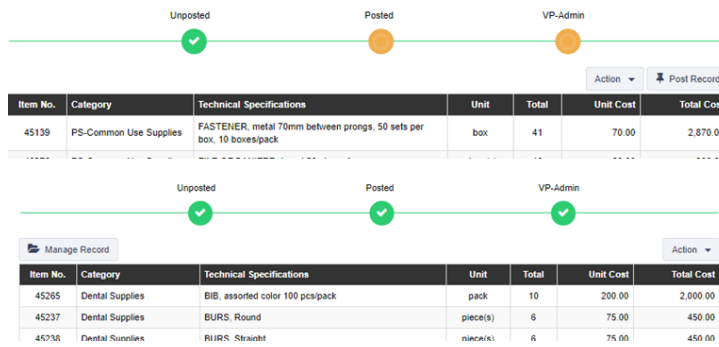

Figure 14. PR status

Fig. 14 shows the status of the Purchase Request. A yellow status means that the PR has not been posted and approved by the VP for Administration. The status is changed to green when the purchase is posted and has been approved by proper authority.

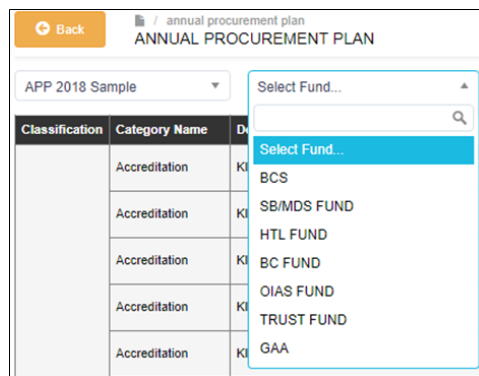

Figure 15. Source of Funding

Fig. 15 shows the source of fund where the item was charged with. Fig. 16 shows a sample of the funding report containing a list of items and total cost charge to a particular fund.

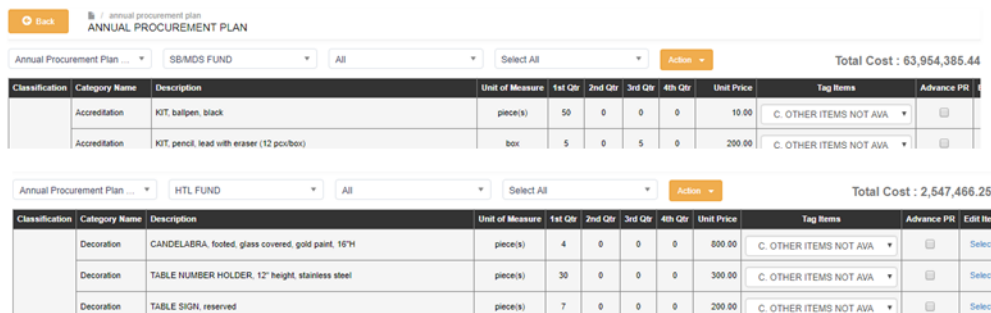

Figure 16. Funding Report

## 4.2. Evaluation of Users and IT Experts

### a. Users

Table 1. Users Evaluation

Criteria	Mean	Verbal Interpretation
Functional Suitability	4.67	Outstanding
Performance Efficiency	4.78	Outstanding
Usability	4.72	Outstanding
Reliability	4.75	Outstanding
Total Mean	4.73	Outstanding

The developed system obtained an Outstanding rating from the users because the system was able to perform the tasks and objectives with precision and was able to meet the needs of the user. Through the system, users were able to create and submit PPMP online, and the procurement unit was able to submit the APP on time. The manual consolidation takes them months to finish, whereas, through this system, it only takes a few minutes to generate the APP. Also, users mentioned that the system is effective since it is easy to learn, is error-free, eliminated double entry and is accessible online.

## b. IT Experts

**Table 2.** IT Experts Evaluation

Interface	Mean	Verbal Interpretation
Security	4.87	Outstanding
Maintainability	4.93	Outstanding
General Mean	4.90	Outstanding

Table 2 shows that the IT experts evaluated the iAMS: Procurement module as Outstanding, because it is secured because of the SSL certificate installed in the system and the passwords, are encrypted. It is also maintainable because the database design is normalized and was able to eliminate duplicate entries. The system is also modifiable if there will be new user requirements like the inclusion of new fields in a report. The web-based interface allows the system to be interoperable and compatible with other web browsers.

## 5. Conclusions

Based on the results of the study, the following conclusions were derived:

1. The developed iAMS: Procurement Module allowed the offices to create and submit their PPMP. The system was also able to automatically generate the APP of TSU, and categorized items based on procurement mode. The system is also capable of monitoring the status and maintaining the procurement activities of the Procurement Unit.
2. Based on the evaluation of the users, the developed iAMS: Procurement Module was able to perform its identified tasks of consolidation of PPMP requirements to the annual APP. Also, the IT experts' overall evaluation of the system was outstanding considering the system's security and maintainability.

## 6. Recommendations

1. The integrated Administrative Management System for Supply and Property Unit be adopted fully by the procurement office to better their office productivity.
2. Increasing the security of the integrated Administrative Management System (iAMS) can be considered if implementation be wide as to the procurement activities.

## References

- Baily, P. (1987). Procurement. In *Contracting for Project Management* (p. 12). Retrieved from <https://www.taylorfrancis.com/books/e/9781351948807/chapters/10.4324%2F9781315259352-7>
- Matharu, G. S. (2015). Empirical Study of Agile Software Development Methodologies: A Comparative Analysis. In *ACM SIGSOFT Software Engineering Notes* (Vol. 40, pp. 1–6). <https://doi.org/10.1145/2693208.2693233>
- Official Gazette. (2016). The 2016 Revised Implementing Rules and Regulations OF Republic Act NO. 9184, Otherwise Known as the Government Procurement Reform Act. Retrieved January 15, 2016, from <http://www.officialgazette.gov.ph/images/uploads/20160826-IRR-RA-9184-procurement-reform.pdf>
- PIDS. (2015). IN FOCUS: Public Tertiary Education In The Philippines. Retrieved November 6, 2018, from <https://www.pids.gov.ph/infocus/82>



# Electric Vehicle with Backup Solar Charger Research Project

Leo P. Piao, Raul D. Canlas, Adam F. Rombaoa, Arnel A. Punla,  
Bernardino P. Nalipay, and Jessie H. Domingo  
College of Engineering and Technology  
Tarlac State University

**Abstract:** This project was primarily conducted to extend the distance travelled by the 68VM e-trike, a commercial electric vehicle produced by BEMAC Electric Transportation Phils., Inc. The backup solar charger system has the following components: 3 pcs. of 100 Watts roof-mounted solar photovoltaic (PV) panels, a 600 Watts Solar Charge Controller (SCC), 6 meters of #16 AWG automotive wires, a 16A miniature DC circuit breaker, a 5A automotive fuse with holder and set of mounting frame and brackets. The research project used Research and Development Method which focused on electrical intervention through addition of an electric solar charging system to the existing onboard plug-in charging system of the vehicle. Prior to the addition of a solar charging system, the vehicle can only be charged during off condition from a 220V alternating current source. But with the addition of a solar charging system, the vehicle was charging while it is running. As a result, the vehicle's distance range on a single full charge was extended from 60 km to 70 km or an approximate average of 10 km increase. The total additional cost of installing the solar charging system amounts to P24,750.00 while the cost to fully charge the battery for 4 hours is P 40.00 to travel a distance of 60 km. This amounts to P0.67 per kilometer and the savings incurred to run the approximate additional 10 km is P6.60. The rate of return on the investment is 0.03% of which can be recovered after 3,750 cycles or equivalent to 46.875% of the battery life cycle. The installation of a backup solar charger is found to be helpful in extending the distance range with no negative effect on the existing electrical system circuit of the vehicle and therefore recommended to other similar units.

**Keywords:** electric vehicle, solar charger, e-trike, backup, photovoltaic, battery

## 1. Introduction

Electric vehicles had been around since 1828 when innovators in Hungary created some of the first small-scale electric cars. It was due to soaring oil prices and gasoline shortages in the early 1970's and issue on environmental concern in the 1990's that propelled interest in electric vehicles (Rebecca Matulka, 2014).

To address this issue on environmental concern, the United States California Air Resources Board (CARB) or the United States Environmental Protection Agency (USEPA) have brought the development of zero - emissions vehicles (ZEV) as their goal to reduce air pollution. ZEV is a vehicle that does not produce any gases to the environment from its power source (CARB, 2018). To-date under the ZEV regulation of the State of California, three distinct designs are considered zero emission through varying degrees: (1) The *Plug-in hybrid vehicles* (PHV) combine a conventional gasoline – powered engine with a battery that can be recharged from the electrical utility grid; (2) Hydrogen fuel cell vehicles (HFCV) runs on electricity produced from a fuel cell using hydrogen gas and (3) *All Electric Vehicles* (AEV) runs entirely on the battery and can be recharged from the electricity grid.

In the Philippines, all electric vehicles are a rare commodity for private used but emerges as a public utility vehicles. According to Rommel Juan of the Electric Vehicle Association of the Philippines (EVAP), the Philippines in partnership with the Asian Development Bank (ADB) and the Department of Energy are planning to replace 200,000 smoke belching public utility passenger vehicles or "jeepneys" and conventional passenger tricycles and by 2020 a million of these all electric public transport vehicles will be deployed on the streets. These electric vehicles will be four - wheeled and three - wheeled electric vehicles all powered by rechargeable batteries for public transport. Three - wheeled electric vehicles are also called e -trikes (Luansing, R.,Pesigan,C.,Rustico Jr, E., 2015).

The proponents of this project found motivation from the work of a man named Louis Palmer in Switzerland where he created an electric vehicle with solar assist (EVWSA) that travelled around the world and the project was named SolarTaxi. He set his technologies on the following specifications: It must be open road with solar energy, Zero CO<sub>2</sub> emission, high efficiency solar cells on a 6 square meter roof - top to drive up to 400 kilometer road using ZEBRA battery technology (Palmer, Louis 2014).

While other researchers focused on converting vehicle with internal combustion engine (ICEV) into battery electric cars (BEV) (Helmers and Marx, 2012) and (Kaleg, Hapid and Kurnia, 2014), this research paper is focused on enhancing the charging system of a commercially available e-trike, the BEMAC's 68VM through installation of a backup solar charging system.

The BEMAC vehicle is a plug – in electric vehicle that uses the power utility system in combination with electronic components to charge its lithium batteries. The BEMAC has also a battery management system (BMS) that monitors several battery parameters such as its voltage over – charging and discharging, over – current charging, unbalanced cells and shorts. Lithium batteries are used commercially for high – end electric vehicles such as the Toyota Prius and other applications such as in telecommunications and in portable devices. Lithium batteries have high energy density properties, higher cell voltage rating of about 4.2 volts and low discharge rate. Applying a backup/secondary charging system will not affect the properties/parameters of the battery as car manufacturers Toyota and Chevrolet have demonstrated and installed in their commercial hybrid electric vehicle (HEV). They have used a secondary source of power such as a gasoline fueled generator to generate electricity for longer distances to charged their HEV lithium batteries and achieve distances from 25 miles to 100 miles (Green Car Congress (2009). This extra mileage gained can be expressed in the overall efficiency of the car in terms of distance travelled which is 400 percent (Beaty, Wayne H & Fink, Donald G., 2013).

## 2. Objectives of the Study

The main objective of the study is to install a solar charging system in order to extend the distance range of the electric vehicle. Specifically, the project aims to: (1) determine the solar charger components and the total cost of installation; (2) determine the resulting additional distance; (3) quantify the amount of savings incurred in the additional distance; (3) compute the rate of return and recovery period and (4) identify any abnormalities in the electrical circuit systems immediately after installation.

## 3. Methodology

The project used Research and Development Method which focused on electrical intervention through addition of an electric solar charging system to the existing onboard plug-in charging system of the vehicle. The following steps summarized the procedure of the project:

1. Purchase a new e-vehicle that is durable and uses induction motor and lithium ion batteries with a built-in charger.
2. Verify manufacturer's specification by test driving and noting all parameters.
3. Study how the existing charging system works along with its electrical parameters before determining the number of solar panels and type of solar charge controller to be used.
4. Purchase of solar panels, solar charge controller, wiring materials and accessories.
5. Install the solar panels with fabricated mounting brackets.
6. Electrical wiring installation.
7. Testing, observation and evaluation.

The e-vehicle that meets the criteria of high durability, uses induction motor and lithium ion with a built-in charger is the 68VM from BEMAC Electric Transportation Philippines, Inc. (Figure 1). This e-vehicle uses Japanese technology which utilizes computer aided engineering analysis for higher durability and strength in the frame design and also passed durability evaluation and bench vibration tests.

Compared to other commercial models of e-trike in the Philippines, the 68VM uses lithium ion battery for better efficiency and longer life cycle. It has the following specifications:

The new e-vehicle upon its arrival to Tarlac State University was scheduled for test driving and at the same time to verify the claims of the manufacturer in terms of its technical specifications. All parameters were observed and recorded and it tallies with the manufacturer’s specification as recorded in the brochure provided.

The existing plug-in charging system were carefully studied by the researchers noting how it works including the amount of voltage and current during charging, mode of charging, switching sequence, cut-off voltage when full charge, the state of charge of the battery and other related parameters that were useful in determining the number of solar panels and the type of solar charge controller to be used.

**Table 1.** 68VM e-trike Technical Specifications

Name of vehicle		68VM
Vehicle class		E-trike
Basic capacity	Max speed	50 km/h
	Distance per charge	60 km (20 km/h constant)
	Gradeability	16°
Motor	Type	AC Induction Motor
	Maximum output	10kW/800rpm
	Maximum torque	70 Nm/800rpm
Battery	Class	Lithium ion
	Total voltage	55.2 V
	Total battery capacity	4.4 kWh
	Total Life Cycle	8,000
Charging apparatus	Setting type	On-board
	Control method of charge	Constant current charging two step type
	AC input	AC 220V single phase
	Time of standard charge	4 hours



**Figure 1.** 68VM e-trike from BEMAC Electric Transportation Philippines, Inc

The solar charger components were then purchased and installed. Mounting brackets were fabricated to adapt to the existing structure of the e-vehicle. After installation, the e-vehicle with back-up solar charger was subjected to series of testing, observation and evaluation.



## 4. Results and Discussion

The following are the results and discussion in answer to the specific objectives:

### 4.1. Solar charger components and the total cost of installation

The backup solar charger system has the following components: 3 pcs. of 100 Watts roof-mounted solar photovoltaic (PV) panels, a 600 Watts Solar Charge Controller (SCC), 6 meters of #16 AWG automotive wires, a 16A miniature DC circuit breaker, a 5A automotive fuse with holder and set of mounting frame and fittings and other miscellaneous materials. The total cost of installation including labor and materials are summarized in Table 2 and the resulting 68VM e-trike after installation of the solar charger is shown in Figure 2.

**Table 2.** Installation Cost of Solar Charger\*

Item No.	Description	Unit Cost	Quantity	Total
1	100 Watts Monocrystalline Solar PV panels	P 5,500	3 pcs	P 16,500
2	600 Watts Solar Charge Controller	2,500	1 pc	2,500
3	#16 AWG automotive wire	15	6 m	90
4	16 A Miniature DC Circuit Breaker	1,200	1 pc	1,200
5	5A Automotive Fuse with Holder	40	1 set	40
6	Aluminum Railing with mounting clips	2,800	1 set	2,800
7	Electrical Tape	45	1 pc	45
8	Miscellaneous materials and labor	1,575	1 lot	1,575
			TOTAL	24,750

\*The unit cost of materials was based on prices as of January 11, 2018 obtained through Philippine Government Electronic Procurement System (PhilGEPS) process.



**Figure 2.** 68VM e-trike after installation of the solar charger

### 4.2. Determination of the resulting additional distance

The 68VM e-trike with installed backup solar charger was subjected to three (3) trial runs and the resulting additional distances were recorded as shown in Table 3.

**Table 3.** Distances During Trial Runs at 20 kph Average Speed

Trial Run	Route	Additional Distance
1	Main, San Miguel, Ungot, Lucinda, Main	9.8 km
2	Main, TRP, Lubigan San Jose, Main	10.1 km
3	Main, San Isidro, Main	9.7 km
	TOTAL	29.6 km
	AVERAGE	9.86 km

The battery was initially fully charged in each trial run and the e-trike was fully loaded and was driven until the battery state of charge reaches the minimum allowable of 10%. During each trial run, the vehicle is maintained at an average approximate speed of 20 kph to simulate and compare with the claim of the manufacturer that the distance per charge is 60 km running at constant speed of 20 kph. The weather conditions in each of the trial runs were generally sunny and the general road conditions are flat and concreted. The result showed that on the average 9.86 km or approximately 10 km was the additional distance incurred due to the installation of the backup solar charger.

**4.3. Amount of savings incurred in the additional distance**

The total additional cost of installing the solar charging system amounts to P24,750.00 as shown in Table 1, while the cost to fully charge the battery for 4 hours assuming a rate of P10 per hour is P40.00 to travel a distance of 60 kilometer. This amounts to P0.67 per kilometer and the savings incurred to run the additional 9.86 kilometer is P6.60.

**4.4. Computation of the rate of return and recovery period**

The rate of return (ROR) on the investment is computed using the formula:

Substituting the data obtained from section (3) will result to:

$$OR = \frac{\text{Savings incurred to run the additional 9.86 km}}{\text{Total Cost of Installation}} \times 100\%$$

The recovery period (RP) can be computed using the formula:

$$ROR = \frac{P6.60}{P24,750} \times 100\% = 0.027\% \text{ or } 0.03\%$$

Substituting the data obtained from section (3) will result to:

The recovery period can also be expressed as percentage (%RP) of the total battery life cycle (equal to 8,000), using the formula:

$$RP = \frac{\text{Total Cost of Installation}}{\text{Savings incurred to run the additional 9.86 km}}$$

$$RP = \frac{P24,750}{P6.60} = 3,750 \text{ cycles of full charge}$$

$$\%RP = \frac{RP}{\text{Total battery life cycle}} \times 100\%$$

**4.5. Identify any electrical circuit abnormalities in the systems immediately after installation**

$$\%RP = \frac{3,750 \text{ cycles}}{8,000 \text{ cycles}} \times 100\% = 46.875\% \text{ of the battery life}$$

There are now two separate electrical systems in the 68VM e-trike that has been integrated at the completion of this project. One is the original electrical circuit and the other is from the solar charger. The electrical circuit systems were carefully observed immediately after integration of two systems and there was no negative effect on the original electrical system. The backup solar charger is equipped with safety components in case any abnormality occurs in its electrical system. It has an automatic circuit breaker and a fuse. In any event that a short circuit is encountered by the solar charger system, the circuit breaker serves as a circuit switch that automatically trips off to isolate the solar panels from the solar charge controller. On the other hand in case of over current flows, the fuse link will melt causing an open circuit to isolate the original electrical circuit from the circuit of the solar charger. Thus, the circuit breaker and the fuse served as indicators of any abnormalities in the

electrical circuit systems after installation. Since there were no automatic trip in the circuit breaker and no melting of fuse link, it is safe to say that there were no abnormalities in the electrical circuit systems immediately after installation.

## 5. Conclusion

The installation of a backup solar charger is found to be helpful in extending the distance range of the 68VM e-trike with no negative effect on the existing electrical system circuit of the vehicle and therefore recommended to other similar units.

## 6. Recommendation

It is highly recommended that a follow-up study should be done on the actual contribution of the backup solar charger to the state of charge of the battery during (1) a particular distance travelled considering weather conditions, number of passengers, manner of driving and road grade and (2) stand still under the sun.

## 7. Acknowledgement

The project proponents would like to acknowledge the full support of the Tarlac State University administration headed by its president, Dr. Myrna Q. Mallari for funding the project and for encouraging and advocating technological researches that promotes green energy such as solar.

Also, the researchers would like to express their gratitude to the personnel and staff of the BEMAC Electric Transportation Philippines, Inc. through its Sales Associate, Raia Marien Galang for providing support to technical inquiries of the researchers regarding the 68VM e-trike.

## References:

- Eckard, H. and M. Patrick. (2012). Electric cars: technical characteristics and environmental impacts. *Environmental Sciences Europe* 24:14. doi:10.1186/2190-4715-24-14. Retrieved from: <https://enveurope.springeropen.com/articles/10.1186/2190-4715-24-14> on September 14, 2017.
- Beaty, W.H. and D.G. Fink. (2013). *Standard Handbook for Electrical Engineers, Sixteenth Edition. Applications of Power Electronic Converters.* The McGraw-Hill Companies, Inc.
- Kaleg, S., Hapid, A. and M.R. Kurnia. (2014). Electric vehicle conversion based on distance, speed and cost requirements. doi: 10.1016/j.egypro.2015.03.276 [www.sciencedirect.com](http://www.sciencedirect.com). Date retrieved: June 19, 2018.
- Lansing, R., Pesigan C. and E. Rustico Jr. (2015). An e-trike ICE project innovative, concrete and ergonomic: systems design to support sustainable e-trike commercialization"
- Matulka, R. (2014). *The History of Electric Car.* Department of Energy. Retrieved from: <https://www.energy.gov/articles/history-electric-car> on June 18, 2018.
- Palmer, L. (2014). Retrieved on June 5, 2018 from [www.solartaxi.com](http://www.solartaxi.com)

## Online Sources:

- Green Car Congress (2009). "2010 Prius Plug-in Hybrid Makes North American Debut at Los Angeles Auto Show; First Li-ion Battery Traction Battery Developed By Toyota and PEVE" Date retrieved: October 08, 2018.
- California Air Resources Board (2018). "Glossary of Air Pollution Terms: ZEV". Retrieved from <https://ww2.arb.ca.gov/>

## WebApp for Energy Management System

Ronnie B. Mercado, Dennis Y. Virtudazo, and Valerie D. Simbol

# WebApp for Energy Management System

Ronnie B. Mercado, Dennis Y. Virtudazo, and Valerie D. Simbol

College of Computer Studies

Tarlac State University

**Abstract:** This paper presents a prototype that was built for the TSU-CCS building. It adapts whatever schedule that will be loaded into it and it is equipped with override control for any unscheduled use and whenever the air conditioning unit is needed to be used besides its predefined schedule. The prototype is one of the many technology, schemes and practices that we should have especially when we have difficulty to go over all the rooms to check whether equipment like an ACU is on or off. We all know that it is far more convenient if we can control them in just one location. IT application should always be for convenience. In the province of Tarlac, there were many IT studies made for businesses, web applications, transaction-based etc... but only a few took a facility-based application study. This is a contribution to the few good examples of building management systems where the use of IT is on electric-powered equipment and how they can be managed. This prototype is envisioned to be one of the models in its kind in Tarlac province.

**Keywords:** WebAp, Internet of Things, Scheduling, Raspberry Pi, Arduino, College of Computer Studies

## 1. Introduction

In the province of Tarlac, the Tarlac State University buildings and facilities have expanded rapidly since its conversion into a State University in 1989. At present, as the university rides along the band wagon of modernization, it also has to deal with the common issues that come with this. The most common issue is the management of the electrically powered equipments and appliances. These things still need to be manually turned ON and OFF. Considering for the fact that a single room contains more than one of these appliances, one can just imagine how many appliances, like an air-conditioning unit (ACU) for example, are there to be managed in one building alone. So, managing these things would be tedious, like turning off the appliances when the room is not in use. Specifically in the College of Computer Studies of the same University, where most classrooms are fully air-conditioned, the neglect of turning these equipments on and off is one of the priority concerns for the Dean, as it is often the constant untoward event in the college that can be evidently seen in their social media group posts and the University Security personnel's report. At present, most structures especially in highly urbanized cities make room for a Building Management System (BMS) in their design, from planning up to occupancy. It is also then that the role of IT becomes mission-critical, for the system will rely on it on the daily operation. BMS controls all electric-powered equipment like elevators, ACUs, generator sets etc... via interface communicating to a central command module. There are varieties of BMS designs and most of them are custom-built to fit the facilities. But since the demand for a much convenient technology calls for a much complex modeling, it is imperative to create computing solutions in a much simpler way.

And even though how diversified the applied technologies are, BMS in its basic essence, still follow a common model, a simple hardware-software communication model.

This study created a prototype that takes into consideration the scheduling schemes of the occupants of the TSU-CCS, adding an advantageous unmanned intervention to the control of ACU's outlet per semester. It is ready for interchangeable hardware interfaces, adaptive software and has provisions for larger implementation.

## 2. Methodology

The researchers used the Research and Development (R&D) design wherein the design relied on the data that were derived by the research phase.

The design is based on the idea of turning the room schedule into a real time automation of switching the ACUs convenience outlet. The prototype is an IP network-based following a Client-Server model. It is a combined software and hardware design. The software, called the ASCon, functions as the server which stores the room schedule and executes the program that sends signal to the ARM through the IP network. The ASCon is installed in a computer that is accessed by the CCS Dean and the College Secretary. The program of the ASCon includes the following features; Import Schedule; Room Viewer; Process Triggers; Customize Triggers. And have the following algorithms; Block then Color Process Trigger and Send Trigger. The hardware, called the ARM, functions as the receiver of the signal from the ASCon. It then performs the actual switching of the ACUs convenience outlet.

The illustration of the hypothetical design of the Adaptive Building Management System prototype shows the simplicity in the communication between the user and the ASCon.

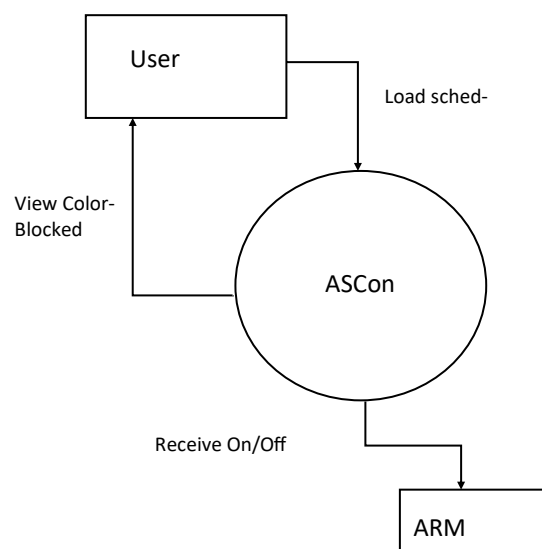

**Figure 1.** Context Diagram of the System

The user loads schedule using the Import Schedule and views the processed schedule in new table format using the Room Viewer. The ASCon accepts and process the loaded schedule. It then produces a viewable table of schedules coming from the Block then Color process and from this processed schedule the ASCon determines the start and end times of classes or block of classes so that it can send the appropriate command signal to the ARM whether to turn ON or OFF the ACU outlet.

The prototype followed the Iterative and Incremental Development method (IID). Craig Larman, in his book *Agile and Iterative Development—A Manager's Guide*, defines "iterative development" an approach to building software (or anything) in which the overall lifecycle is composed of several iterations in sequence. Each iteration is a self-contained mini-project composed of activities such as requirements analysis, design, programming, and test. The goal for the end of iteration is an iteration release, a stable, integrated and tested partially a complete system.

IID is a process that grows a system feature by feature during self-contained cycles of analysis, design, and development and testing that end in the production of a stable, fully integrated and tested, partially complete system that incorporates all of the features of all previous iterations.

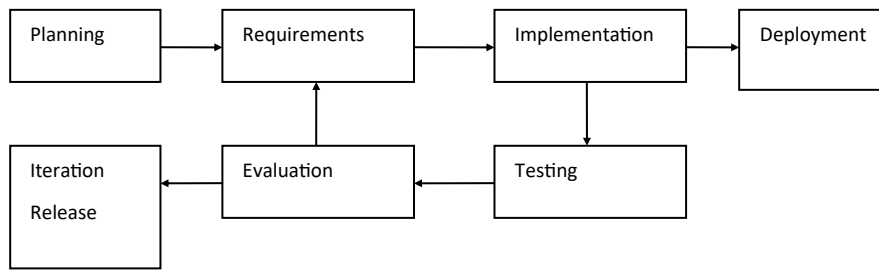

Figure 2. IID Model Diagram

The researchers’ approach was from hardware up to the software so the development started on the hardware part. The ARM is the device between the convenience outlet and the ACU’s plug. It has two important functions. It receives the signal from the ASCon and it switches the outlet ON or OFF.

### 3. Results and Discussion

Seen in figure 3 is the Import Schedule feature. It visualizes the instructions to do the task of: Importing the .XLS files that come from the TSU Enrolment System using the Import button; Processing the imported schedule by the Process Triggers’ button; Viewing the schedule using Room Viewer button.

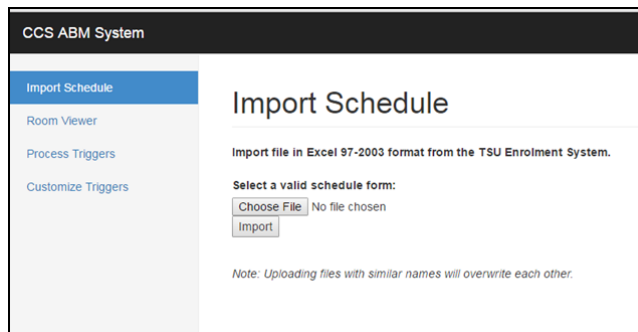

Figure 3. The ASCon GUI.

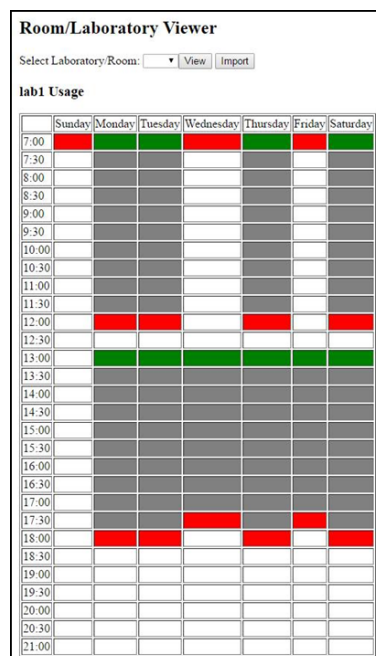
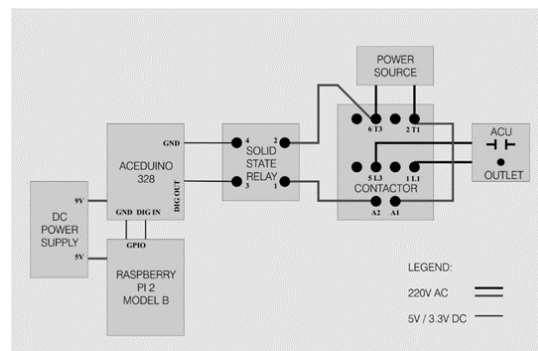

Figure 4. The Room Viewer showing the start (green) and end (red) time triggers.

Figure 4 shows the View Room Usage feature of the ASCon. This is the output of the Block then Color Algorithm. The Start Time is colored Green and the End Time is colored Red, Grey represents a scheduled class or activity, and White color represents a vacant period. The important colors here are Green and Red; Green denotes an ON trigger while Red denotes an OFF trigger. This is done by the Process Triggers. These triggers are then sent to the ARMs via IP for the execution of the switching action.

The latest design (see Figure 5) now is the RPi that is connected to the ACEduino328, which is connected to the SSR, which is connected to the contactor, which is connected to a convenience outlet. And after repeated and prolonged testing, the design for the ARM was finalized.



**Figure 6. Final diagram of the ARM**

#### 4. Conclusion

Based on the findings of the study, the following conclusions were drawn:

1. The prototype's design changed as the development went on. The researchers concludes that when all factors are realized and considered in small cycles of planning, requirement selection and evaluation, the attempt to pursue next phase in building a prototype with a specific task is easier.
2. The study was successful after subjecting the prototype in three different kinds of evaluation and passing them all. The evaluation by repeated testing which refined the components to work harmoniously as a working prototype, the evaluation by the users which scored the ASCon's looks and functionality, and the evaluation by the electrical experts which scored the ARM's electrical safety.
3. The researchers' use of the criteria for evaluating the prototype as guidelines was significantly helpful in achieving the objectives of the study. The criteria for evaluation are meticulously important. The criteria must correlate to the target objective, each one giving support to the next criterion. The prototype passed all of the criteria because the criteria themselves served as guidelines by the researchers while on the development stage.
4. Electrical safety not only includes the type of materials used, the appropriate sizes, and the design layout. It also includes the behavior of the devices. Each component should be carefully studied and tested before finalizing the design.

#### References:

##### Books

- Balamiento, Narciso M. and the Alexan R&D Team (2013). Learning Arduino Using Alexan Training Shield. ACE Electronic Technology, Inc.
- Sklar, David (2004). Learning PHP5. O' Reilly Media

## Unpublished Materials

De Los Reyes, Edjie M. (2009). Integrated Control System Model for the College of Computer Studies Building. Tarlac State University

Dizon et al (2002). Automated Electrical Energy Saving System. Systems Plus College

## Online Sources

Australian Government, Department of Climate Change and Energy Efficiency, EEGO PGPA Act (2013). <http://www.industry.gov.au/Energy/EnergyEfficiency/Non-residentialBuildings/GovernmentBuildings/EnergyEfficiencyOperations/Documents/bms-guide.pdf>

Krioukov, A. (2011). A Living Laboratory Study in Personalized Automated Lighting Controls <http://raspberrypi.stackexchange.com/questions/36514/properlywiringasolid-state-relay-to-the-gpio-pins>

[http://faculty.kfupm.edu.sa/ARE/amhammad/ARE-457courseweb/Building Management-System.pdf](http://faculty.kfupm.edu.sa/ARE/amhammad/ARE-457courseweb/Building%20Management-System.pdf)

<http://www.phpreferencebook.com/html-version/>

<http://www.eecs.berkeley.edu/~krioukov/PersonalizedLightingControls.pdf>

[http://www.lonix.com/specifications/Lonix\\_IBMS\\_specification.pdf](http://www.lonix.com/specifications/Lonix_IBMS_specification.pdf)





# The Use of Edmodo with Journal Writing in Teaching Mathematics

Nelvin R. Nool and Jessie B. Aquino  
College of Education,  
Tarlac State University

**Abstract:** Technology nowadays has been considered an integral part of the classroom learning environment for it provides a tool for both teachers and students to facilitate new roles and new instructional strategies. In the field of mathematics pedagogy, technology is likewise recognized to be an essential tool in enhancing the learning outcomes of the students. Also, writing in Mathematics class helps students stretch their thinking and is considered as a good way to understand mathematics. This study explored the effectiveness of using Edmodo with Journal Writing (EJW) in teaching Mathematics. Employing experimental design, the study found that the use of EJW was effective in increasing the performance and retention of the students in Mathematics. Moreover, the students found the use of EJW effective in learning Math. Problems encountered on the use of EJW were identified and solutions to address them were also proposed.

**Keywords:** Edmodo, Journal Writing, Mathematic

## 1. Introduction

Technology is becoming more prominent in today's classrooms, and one thing which is surely undeniable, it brings the usual classroom set up of students and teachers into a more engaging, interactive and fun venue of teaching – learning process. It has become an essential tool for doing mathematics in today's world, and thus that it is essential for the teaching and learning of mathematics (AMTE, 2006; NCTM, 2000) and at all levels, there have been multitudes of research showcasing the benefit of how technology can enhance the learning outcomes of students.

Mathematics, to most, is a complex and difficult subject. Teachers reflected that there are students who are not really interested in learning the mathematics which resulted to low performance in the said subject. The tendency for most students is to consider the subject as one that is boring, thus, creating lack of interest in the topics being discussed. This poses a great and extra challenge for teachers and educators on how to transform their classroom that will invite the vigor and interest of the students to learn mathematics at its best by providing them technological tools and innovations that will maximize their potentials in learning the subject.

Potentially, technology increases productivity in educational activities and affects the quality of education in terms of meaningful learning and effective teaching. The use of technology offers the possibility to solve problems and enhance the stability and quality of learning in a coherent manner (Isman, 2003). Technology is not only electronic instruments but rather, a comprehensive collection of tools which includes new teaching-learning methods which brings about positive benefits in student learning (Wahyudi, 2008) and provides concrete evidences of ICT having an impact on teaching and learning in the classroom (Harrison, 2005).

The integration of technology in mathematics education also help solved the students' problem in learning the subject brought about by their low motivation to learn math, difficulties of transferring problem solving skills to real life situations and giving low value in learning mathematics (Isman, 2003). That's why, educators and researchers have always been passionate and eager to encourage and inspire teachers to maximize and articulately integrate the use of technology in their teaching to vary the usual classroom set up and be able to effectively improve learning performance among the students (Sutton, 2006; Jedege, 2008).

With the demands of the 21st century education, learning mathematics should always focus in an engaging learning process, giving the students the opportunity to show confidence in doing mathematics. This will help them better grasp and concretize the concepts undertaken to become dynamic and active participant and making the teaching-learning process meaningful. It further exemplifies that 21st century math classrooms are not defined only with program adoptions, learning resources and online tools, but rather are defined by what should students learn (Mahajan, 2014) and how the learning experience is brought to life through these programs, learning resources and tools.

The 21st century mathematics education therefore must anchor on how to develop authentic learning experiences, emphasizing the mastery of processes, the understanding of concepts, and the ability to function in different situations in each domain, rather than the possession of specific knowledge (PISA, 2003). Students should be provided the ownership of their learning path with choice, application, discovery, struggle, success, and feedback through effective utilization of technology. This learning venue showcases that a 21st century-technology integrated mathematics classroom is one that has expectations for all math learners to achieve at high levels, a place where meaningful learning is pulled off, which is the mathematics pedagogy's primary function.

Research shows the growing importance of using online communities of practice for the professional development of teachers. In particular, they are used to help teachers and educators reflect on their practices in a collaborative and supportive learning environment (Kirschner & Lai, 2007). These applications work as social networks and are applications based on web 2.0 technologies, allowing users to share personal knowledge with each other (Hossain & Wiest, 2013). The use of different online social network sites offers perfect communication tools for constructing knowledge which can be done through social relationships, communication, linkages, and task sharing. This includes Whiteboard, WordPress, YouTube, Facebook, LinkedIn, MySpace, Nexopia, Twitter, Edmodo and many others. (Balasubramanian, Jaykumar & Fukey, 2014; Hossain & Wiest, 2013).

Edmodo is an interactive application and was ranked one as the best free learning tool used by professionals all over the world (Hart, 2015), that can be used on both mobile devices and in the web environment to create an online community of practice and collaboration in a virtual classroom environment (Curran-Sejkora, 2013; Balasubramanian, Jaykumar & Fukey, 2014; Ekmekçi, 2016; Mokhtar, 2016). It is a free social learning platform which highlights the social side of learning since its interface is quite similar to Facebook. It allows users to upload and share links to websites and an array of digital files which are not permitted in some platforms.

Journal writing, on the other hand, plays a pivotal role in the development of deeper understanding and abstraction of mathematical concepts among students (Aquino, 2015a). Their ability to communicate mathematically is realized when they are able to illustrate, interpret, explain and discuss mathematical ideas to their teacher, internally to themselves, and to their classmates (Pugalee, 2004). The students feel the sense of ownership of their learning since they experience doing mathematics (MOE-Singapore, 2000). It also allows the teacher to check the extent of their learning through their writings especially those who have difficulties of expressing themselves orally. It is also an effective tool to increase teachers' understanding of students' learning in math as well as students' attitude towards math learning and teaching (Yeo, 2001).

Teachers at all levels face a lot of challenges in teaching mathematics at its best and so changing students' overall approach to learning mathematics is something that requires them to exert extra effort and courage to find a simple but engaging and enjoyable approach in teaching the subject. This gives way to the use of Edmodo with journal writing by the researchers, with the belief that these could be utilized as a valuable means to facilitate a personalized and making-of-meaning approach by the students in learning mathematics. Through the use of Edmodo with journal writing, students will be illuminated to respond to a teacher's request for evidence of mathematical understanding and will have the capacity to report what they want the teacher to know, they can also have the ability to reflect on their own learning, and are able to relate to the teacher as a partner in their learning (Mason & McFeetors, 2002).

Moreover, the Philippines is frequently visited by typhoons that causes class suspension for some days. This substantially decreases the number of school days and may result to less learning opportunity. With the use of Edmodo, students who may be absent from class especially during typhoon, can have access to the learning material presented in the classroom and can catch up with the lesson. Thus, Edmodo may serve as an alternative mode of learning delivery.

This study aimed to examine the effectiveness of the use of Edmodo with Journal Writing (EJW) in teaching mathematics; to determine whether it promotes retention of skills; to determine students' perception on the effectiveness of EJW and its relationship with their performance; to identify the problems encountered in teaching mathematics using EJW; and to propose solutions to address the problems in using EJW in teaching mathematics.

## 2. Methodology

### 2.1. Research Design

The one-shot experimental design was used in this study to test the effectiveness of Edmodo with Journal Writing (EJW) in teaching mathematics. It includes the pretest, posttest, delayed posttest and the students' perception on the effectiveness of EJW as the primary tools in gathering the necessary data in this study. The one-shot experimental design is:

$$\underline{R \quad O1 \quad X \quad O2 \quad O3}$$

where: R = Grade 11 Students, O1 = pretest of the students, X = use of Edmodo with Journal Writing, O2 = posttest of the students, and O3 = delayed posttest of the students.

The following null hypotheses were tested at .05 level of significance: (1) There is no difference between their scores before and after the students were taught using EJW, and (2) There is no difference between their scores in the posttest and delayed posttest.

### 2.2. Participants

The participants in this study were the thirty-five (35) Grade 11 students under the General Academic Strand (GAS) of the present school year. Of the 35 students, 12 were male and 23 were female. The students had a mean age of 17 years old and had a satisfactory mathematics performance based on their mean rating of 80.23% in Grade 10.

### 2.3. Methods of Gathering Data

The group of students was taught with the use of EJW. The experimentation lasted for eight weeks (40 days) covering the topics on functions and relations, rational functions, inverse functions, and exponential functions. Students were oriented on the features of Edmodo (how to sign up and use) before they created their own account. The students are also provided with a journal template which they completed every end of the topic. The journal writing template developed by the researchers features the three elements which included the Affective/Attitudinal (how do the students feel about the topic), Mathematical Content (what is the topic about), and the Process (explain how to do math). Pretest, posttest and delayed posttest were the bases of interpretation of results. A fifteen-item instrument using a 4-point Likert scale on the effectiveness of EJW as perceived by the students, developed by the researchers and validated by experts was also given to determine whether it has a relationship with their performance. The Likert scale was utilized to evaluate the effectiveness of Edmodo with journal writing. It provides items where students can use criteria and standards to support ideas in evaluating the use of Edmodo with journal writing by indicating their degree of agreement or disagreement on statements like: *Edmodo with journal writing increased my motivation to learn mathematics; Learning mathematics using Edmodo with journal writing contributed into the de-*

*velopment of my academic achievement in mathematics; The use of Edmodo promoted cooperative learning, making us students more active and engaged in the learning tasks since it is more fun and enjoyable than learning it the traditional way; The use of Edmodo with journal writing helped improve my critical thinking skills and retain more information learning mathematics than if I had not used them; Edmodo makes learning mathematics more accessible since it removes the limitation of place and time; etc.* It covers how students affect their way of learning mathematics using Edmodo and journal writing. It also identifies how the Edmodo with journal writing had helped them exemplify better performances after they had used it.

## 2.4. Procedure

Before the beginning of the experiment, the students were given a pretest composed of forty (40) items with a moderate difficulty level of 0.68, a discrimination index of 0.43 and a reliability index (KR20) of 0.80. This is to determine their initial knowledge before the experimentation. Included in the test are items where the skills of the students to remember concepts, solving for the unknown value of the variable and solving problems involving the application of the learned competencies on functions and relations, rational functions, inverse functions, and exponential functions. The students were taught on the topics functions and relations, rational functions, inverse functions, and exponential functions.

Lessons were presented using powerpoint which is also made available in the Edmodo. After each lesson, apart from the activities given during regular class session additional activities were provided in the Edmodo where students are encouraged to complete it as scheduled. Quizzes, assignments, poll questions, and discussions were some of the activities uploaded and students can access it anytime, anywhere as long as they're online. Students are given the whole week to finish all the activities provided in the platform. Results of the activities were presented and discussed in the class on the fifth day of the week. Also, students were give the journal writing template and asked them to fill out after each lesson.

After eight weeks (40 days) of exposure, the students were given a posttest, the same as the pretest given and compared. The increase in means determined the effectiveness of the use of Edmodo with journal writing in teaching mathematics. A forty-item open ended delayed posttest was also administered after a week to measure the skills retained among the students. The increase in means in their delayed posttest is used as basis of concluding that there was retention of learning using Edmodo with journal writing. A questionnaire about students' perception on the effectiveness of Edmodo with journal writing was administered after the delayed posttest and then tested to find its relationship on their performance.

## 2.5. Statistical Treatment

The mean and the mean percentage score (MPS) were used to describe the pretest posttest and delayed posttest scores of the students. To determine the variability of the scores of the group, the standard deviation was employed. The paired sample *t*-test was used to determine the significant difference between the performances of the students in their pretest, posttest, and delayed posttest.

For the interpretation of students' performance, the following categories were used:

MPS Range	Description
90% - 100%	Outstanding
85% - 89%	Very Satisfactory
80% - 84%	Satisfactory
75% - 79%	Fairly Satisfactory
74% - below	Did Not Meet Expectations

In terms of the students' perception on the effectiveness of the use of EJW, the following indices were used:

Numerical Rating	Students' Response	Descriptive Ratings
3.26 – 4.00	Strongly Agree	Very Effective
2.51 – 3.25	Agree	Effective
1.76 – 2.50	Disagree	Ineffective
1.00 – 1.75	Strongly Disagree	Very Ineffective

To establish the relationship between the students' perception on the effectiveness of the use of EJW and their performance, the Spearman's rho was used. The following indices were used in interpreting the coefficients of correlation (De Guzman, 2017:224):

Correlation Coefficient	Interpretation
+ 0.80 - + 1.00	Very strong
+ 0.60 - + 0.79	Strong
+ 0.40 - + 0.59	Moderate
+ 0.20 - + 0.39	Weak
+ 0.00 - +0.19	Very weak

### 3. Results and Discussion

#### 3.1. Effectiveness of the Use of Edmodo with Journal Writing (EJW)

One of the objectives of this study is to describe the students' prior knowledge in general mathematics before they were exposed to the use of Edmodo with journal writing. Table 1 shows the performance of the students in mathematics. In their pretest, the students obtained a mean of 19.69 (MPS = 49.23%) and a standard deviation of 3.67. This implies that the students' mastery level on the lesson included in the test is only 49.23% (Did Not Meet Expectations). This showed further that the students had low initial knowledge on the competencies of functions and relations, rational functions, inverse functions and exponential functions.

**Table 1.** T-Test between the Means of Pretest and Posttest

	Posttest	Delayed Posttest	Difference	<i>t</i>	<i>df</i>	<i>p</i>
Mean	19.69	32.23	12.54			
				-20.61	34	00
St. Dev	3.67	2.81				

On the contrary, most of the scores in their posttest are high (mean = 32.23, SD = 2.81) giving an MPS of 80.58% (Satisfactory). This high performance of the students could be resulted from the use of EJW, since it was observed that students become more enthusiastic in the subject, every time the classes start. Students become more interested by asking the teacher with excitement on the results of the activities they have done. It enables students to become more engaged and interested in the lesson. Many of them become more participative during class discussion and had always been excited at completing the activities in the Edmodo with their soonest time possible. The use of EJW showed a positive effect not only on the students' achievement but also on their learning engagement and behavior towards the subject (Charoenwet & Christenses, 2016). Students become more active since they were provided the possibility of sharing knowledge, experiences and views (Ekici, 2017).

The use of journal writing in mathematics also contributed to the improvement on the performance of the students. They were able to express their thought processes, problem-solving strategies, and the steps they used to work problems. Their journals also helped the teacher to evaluate

their understanding of skills and progress (Lindsay, 2006). The use of it positively affects their attitudes toward the subject, skill development, and concept mastery because they were given the opportunity to communicate what they have learned.

In addition, journal writing supports the students' mathematical reasoning, to check whether they were able to translate, consolidate and internalize their thinking (Pugalee, 2005). Likewise, it has offered the students not only a growth opportunity but also the opportunity to receive better-focused teaching strategies, considering that journal writing requires them to reflect on their work and clarify their thoughts about the ideas presented (NCTM, 2000). Journal writing therefore, served both as a learning tool and as a coaching tool which resulted to better performances of the students.

To show statistically that the use of EJW in teaching mathematics significantly improved students' performance, a dependent sample *t*-test between means was conducted. The statistical analysis presented in Table 1 shows the significance of the difference between means (12.54) of pretest and posttest. Based on the table, since  $t(34) = -20.61$  and the *p*-value  $< 0.01$ , this is highly significant which indicates a strong evidence to reject the null hypothesis that there is no difference between their scores before and after the students were taught using EJW. It is further concluded that the performance of the students greatly improved after they have been taught using EJW, which confirms that the use of it was effective and helped the students become more engaged in the lessons (Al-Said 2015; Aquino, 2015b). Students have shown a deeper understanding of mathematics which is exemplified by the increase in their MPS from 49.23% to 80.58%. The use of EJW has contributed to the development and understanding of the students on the mathematical concepts and processes included in the topics covered. It helped them visualize with these concepts more concretely (Nool, 2012a). Furthermore, it encouraged the students to participate actively in online discussion among them as well as to even contact the teacher for some questions and clarifications that they had about the lesson (Enriquez, 2014; Thongmak, 2013; Majid, 2011).

The use of journal writing likewise helped the students consolidate their thinking because it required them to have a reflection on what they have learned in every session. Furthermore, it allowed them clarify their thoughts about the ideas they have taken up after the lesson (NCTM, 2000; Aquino, 2015a).

### 3.2. Retention of Skills

Another indicator of the effectiveness of the use of EJW is the retention of skills in the topics covered (functions and relations, rational functions, inverse functions and exponential functions). Students' retention of skills is measured by comparing their posttest and delayed posttest scores. Increase in their delayed posttest over their posttest determined the effectiveness of Edmodo with journal writing in the retention of skills. These scores were statistically tested using *t*-test of difference between means of correlated samples. The results are presented in Table 2.

**Table 2.** T-Test between the Means of Posttest and Delayed Posttest

	Posttest	Delayed Posttest	Difference	<i>t</i>	<i>df</i>	<i>p</i>
Mean	32.23	36.06	3.83			
				-9.61	34	00
St. Dev	2.81	2.26				

The statistical analysis in Table 2 shows the significance of the difference between means (3.83) in the posttest and delayed posttest. Since  $t(34) = -9.61$  and the  $p$ -value  $< 0.01$ , it can be noted that this is highly significant. This indicates a strong evidence to reject the null hypothesis that there is no difference between their scores in the posttest and delayed posttest. Students who were taught using Edmodo with journal writing exemplified a remarkable improvement in their performance. The performance of the students in mathematics still improved significantly from 80.58% (Satisfactory) to 90.15% (Outstanding) even a week after the teaching sessions using the Edmodo with journal writing.

Figure 1 shows the distribution of the students as to mean percentage score (MPS). It can be gleaned that pretest results of the students were on below expectation of the passing percentage of 75% MPS. All the 35 students were on the "Did Not Meet Expectation" level (MPS = 74% below). This means that they don't possess yet the necessary skills and mastery of the competencies included in the first quarter lessons.

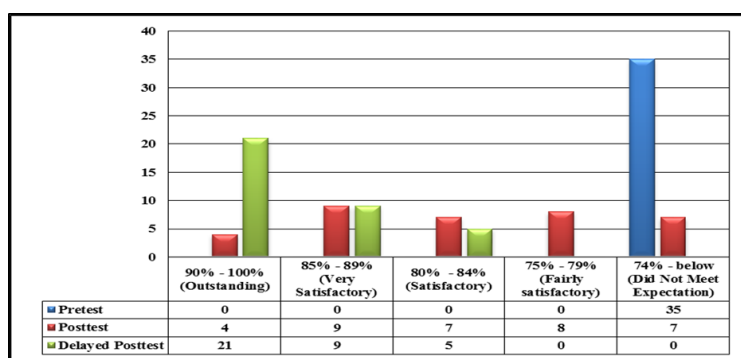

Figure 1. Performance of the Students in Mathematics

In their posttest, their performance greatly improved. There were 8 of them whose mastery level is "Fairly Satisfactory" (MPS = 75% - 79%), 7 or 20% in the "Satisfactory" level (MPS = 80% - 84%), 9 or 25.71% were in the "Very Satisfactory" level (MPS = 85% - 90%), and 4 or 11.43% falls on "Outstanding" level of mastery (MPS = 90% - 100%).

Their delayed posttest results also showed that their performance had even further improved. The use of Edmodo with journal writing enhanced the learning and understanding of the students on the concepts and skills covered in the lessons. Majority of the students (21 or 60%) had an "Outstanding" level of mastery with a MPS of 90% - 100%. There were also 9 or 25.71% in the "Very Satisfactory" level (MPS = 85% - 90%) and 5 or 14.29% in the "Satisfactory" level (MPS = 80% - 84%).

This result can be attributed to the use of Edmodo with journal writing which helped students promote their ability to visualize clearer the different concepts, enhanced retention of the concepts and processes. It helped encourage the students to use Edmodo as a support and communication such as forum and online discussion of mathematical concepts (Balasubramania & Fukey, 2014) which resulted to better achievement and retention of the students' skills on the said topics. The findings of the study implied that Edmodo is a good tool to improve students' learning opportunities through active participation and communication to support face to face learning environment (Uzun, 2015). The students were given an opportunity to actively participate in the discussions and activities provided in the platform which they find it difficult to do during classroom discussion. Some of them who didn't have the enough strength and confidence to do math during classroom discussions, participated actively in the activities found in the learning platform.

Journal writing also helped students improve learning of mathematics since they were required to reflect on what they have learned by involving other thought processes in order to be able to write (Cheng & Feyten, 2015; Parker & Breyfogle, 2011). Students were able to clarify their thoughts and engage their thinking in a meaningful way. It shows further that the more the students reflect and think in their learning, their retention of ideas and concepts is more evident. Students were able to associate their learning by means of reflective writing in mathematics (Pugalee, 2004; Nool, 2012b). The teacher was able to pinpoint where and what part of the lesson seemed to be still



unclear to students since the journal requires reflection on the specific lessons given and included in the template. From there, the teacher was able to do some remediation and enrichment activities to strengthen the learning of the students. Furthermore, the use of EJW encouraged students to be an active participant in the teaching-learning process becoming more engaged and motivated during the discussion.

### 3.3. Students' Perception on the Effectiveness of Edmodo with Journal Writing (EJW) and its Relationship to their Performance

Another objective of the study was to determine the relationship of the students' perception on the effectiveness of the use of EJW in teaching mathematics and their performance which is presented in the next table. This is to further verify that the result of high performance of the students can be accounted from the use of EJW. Cronbach alpha was used to determine the reliability and internal consistency of the items of the research instrument with regard to the perceptions of the students on the effectiveness of EJW. It was found to be 0.76, an acceptable alpha coefficient (Multon, 2006; Tavakol & Dennick, 2011; Andale, 2014), which means that the items included in the 4-point likert scale are accepted and intend to measure what it should.

It can be gleaned from Table 3 that the overall students' perception on the effectiveness of the use of EJW is "very effective" with an overall mean of 3.54 and a standard deviation of 0.18. Students believed that the use of journal writing played a significant role in enhancing their learning outcomes and performance in mathematics. This shows that students who were exposed to the use of the said intervention exhibited a positive attitude towards it. Their learning outcomes were enhanced as it indicates positive effect when participating in the learning setting as reflected in their learning engagement and behavior (Luechefeld, 2013; Penwell, 2011). The use of Edmodo provided a private virtual space for students and teachers to share and discuss text, images, slide presentations and interactive lessons. Furthermore, it allows students to interact with one another more personally which encouraged discussion and feedback from fellow students as well as from the teacher.

Likewise, journal writing deepened the understanding of the students on mathematical concepts and processes. It gives them the opportunity to explain their work, communicate their thinking, and give examples of their own, providing the teacher with the information he needs to adjust, modify and even enhanced his instruction (Pugalee, 2005).

**Table 3.** Student's Perception on the Effectiveness of Edmodo with Journal Writing

Table 3. Students' Perception on the Effectiveness of Edmodo with Journal Writing		
Statements on Students' Perception on the Effectiveness of EJW	Mean	Descriptive Rating
1. Edmodo with journal writing increased my motivation to learn mathematics.	3.63	Very Effective
2. Edmodo helped me get immediate feedback in learning mathematics.	3.40	Very Effective
3. Learning mathematics using Edmodo with journal writing contributed into the development of my academic achievement in mathematics.	3.43	Very Effective
4. Journal writing helps improved my achievement in Mathematics since it gives me the opportunity to communicate my learning through writing in the journal.	3.66	Very Effective
5. The use of Edmodo promoted cooperative learning, making us students more active and engaged in the learning tasks since it is more fun and enjoyable than learning it the traditional way.	3.66	Very Effective
6. Writing math journals help me connect mathematics in the real world.	3.37	Very Effective
7. The use of Edmodo with journal writing helped improve my critical thinking skills and retain more information learning mathematics than if I had not used them.	3.31	Very Effective
8. Edmodo makes learning mathematics more accessible since it removes the limitation of place and time.	3.71	Very Effective
9. Journal writing helps me gain a deeper understanding on the different math concepts as journal writing allows me to write my learning which I find it difficult to do orally.	3.60	Very Effective
10. The use of Edmodo facilitates our interaction and communication with the teacher on the topic discussed.	3.46	Very Effective
11. I enjoyed using Edmodo in learning mathematics since it gives me the opportunity to be involved in the different activities made available in the learning platform.	3.80	Very Effective
12. Journal writing has helped me communicate my learning with my Math teacher and has served as tool to evaluate the extent of my understanding of the lesson.	3.46	Very Effective
13. The use of Edmodo with journal writing helped encourage the interaction and participation of isolated students.	3.51	Very Effective
14. The use of Edmodo eases the access of mathematical concepts and procedures in any time and at any place.	3.63	Very Effective
15. Edmodo with journal writing has provided me the venue to explain my understanding on the different mathematical concepts and procedures.	3.54	Very Effective
N = 35    Min. = 3.31    Max. = 3.80    SD = 0.18    Overall Mean = 3.54    Overall DR = Very Effective		

Table 4 presents the values obtained using Spearman's rho. Spearman rank correlation is a non-parametric test that is used to measure the degree of association between two variables and is the appropriate correlation analysis when the variables are measured on a scale that is at least ordinal (Chen & Popovich, 2002).

**Table 4.** Correlation between Students' Perception on the Effectiveness of EJW and Performance

	Delayed Posttest
Students' Perception	0.848**

\*\* *Correlation is significant at the 0.01 level (2 tailed).*

Table 4 shows the significant relationship between students' perception on the effectiveness of the use of EJW in mathematics and their performance. The table shows that at 0.01 level of significance, there is a sufficient evidence that the students' perception on the effectiveness of the use of EJW is significantly and positively related to their performance ( $r = 0.848$ ,  $p < 0.01$ ). The correlation shows that there is a strong positive relationship of the two variables involved. This indicates that students who perceived that the use of EJW is effective tend to have better or higher performance in mathematics. It implies further that the higher the students' perception on its effectiveness, the greater the possibility that they exhibit excellent performance in mathematics.

Conversely, students whose perception on the effectiveness of the use of EJW is low, tend to have lower performance also. This further indicates that the use of EJW enhanced the learning outcomes of the students. Students are more engaged in the teaching-learning process since they were given different opportunities of learning the lessons.

Findings revealed that students had a positive attitude towards the use of Edmodo. This shows therefore that Edmodo is a good tool to improve students' learning opportunities through active participation and communication. The use of this learning management tool encouraged them to be active in classroom and even outside the classroom (Uzun, 2015).

Journal writing also contributed to the improvement of students' learning outcome. The more the students involve themselves in their reflection and thinking on their learning, a better retention of concepts and ideas is exemplified by them. Students were able to associate their learning by means of reflective writing in mathematics (Pugalee, 2004).

### 3.4. Problems Encountered in Teaching Mathematics Using Edmodo with Journal Writing

There were only few problems met during the implementation of the use of EJW. Some of the problems identified were on the technical side of the learning platform and some grammatical weaknesses in the writing of journals. These include the need of internet connection to access the Edmodo; some document formats are not supported by the mobile version of the learning platform; very few students do not have mobile phones that support Edmodo; insufficient mastery of the command to access the learning platform; difficulty of expressing one's self using the English language; and limited time to finish writing the journal every end of the lesson.

### 3.5. Proposed Solutions to Address the Problems

The following solutions are proposed to address the problems: (1) The school should work out on making internet connection available to support diversified ways of learning. (2) Develop and provide materials uploaded in the learning platform whose format is supported by the tools used by the students. (3) Students who do not have mobile phones can be paired to their fellow students, especially those who are neighbors. (4) Provide a comprehensive tutorial on the different commands,

functions, and features using the Edmodo. (5) The use of Filipino language in writing their journals may be considered. (6) Additional time may be given to complete writing their journals.

#### 4. Conclusions

Changing students' overall approach to school mathematics presents a task for which one cannot hope to find a simple or even unique solution. Nevertheless, the use of Edmodo with journal writing (EJW) can provide students a valuable means to facilitate a personalized and making-of-meaning approach to learning mathematics.

Based on the results and findings, the following conclusions were derived: (1) The use of EJW improved the performance of the students. They obtained higher mean in their posttest compared to their pretest which lead to higher mean percentage score. (2) Delayed posttest also increased with the use of EJW as compared to their posttest which resulted to higher mean percentage score. (3) Students' perception on the use of EJW after instruction is that it is very effective. (4) There is a very strong positive correlation between the students' perception on the effectiveness of Edmodo with journal writing and their performance. (5) Some of the problems encountered on the use of Edmodo were on the technical aspect of the learning platform which include the need of internet connection to access it; not all document formats are supported by the mobile version of Edmodo; few students do not have mobile phones to use it; and mastery of the commands and features on how to use it. Also in the journal writing, problems on difficulty of expressing thoughts and ideas using the English language and limited time to complete writing their journal in each session were identified. However, proposed solutions are presented to be able to address these problems to maximize the use of Edmodo with journal writing in improving the mathematics performance of the students.

#### References

- Al-Said, K. M. (2015). Students' perceptions of Edmodo and mobile learning and their real barriers towards them. *The Turkish Online Journal of Educational Technology*, 14(2), 167-180.
- Aquino, J. B. (2015a). The Effectiveness of Payne-Rathmell Triangle Model with Journal Writing in Teaching Geometry. *International Conference on Science and Mathematics Education*. SEAMEO RECSAM, Penang, Malaysia.
- Aquino, J. B. (2015b). The Effectiveness of the Use of Information and Communication Technology (ICT) in Teaching Mathematics. *International Conference on Science and Mathematics Education*. SEAMEO RECSAM, Penang, Malaysia
- Association of Mathematics Teacher Educators (AMTE). (2006). *Preparing teachers to use technology to enhance the learning of mathematics: A position of the Association of Mathematics Teacher Educators*. Retrieved from <http://amte.net/sites/default/files/amtetechnologypositionstatement.pdf>
- Balasubramaniana, K., Jaykumar V., Fukey. L. (2014). *Student preference towards the use of Edmodo as a learning platform to create responsible learning environment*. Taylor's University, Subang Jaya, Selangor, Malaysia
- Chen. P. Y., & Popovich, P. M. (2002). *Correlation: Parametric and nonparametric measures*. Thousand Oaks, CA: Sage Publications
- Cheng, R., & Feyten, C.M. (2015). Students' academic literacy development guided by teacher written feedback: *A writing-to-learn perspective*. *Studies in Applied Linguistics*
- Curran-Sejkora, E. L. (2013). *Student Interactions in Edmodo versus Facebook* (Doctoral dissertation). Retrieved from <http://hdl.handle.net/2286/R.1.20858>
- Ekmekçi, E. (2016). *Integrating Edmodo into Foreign Language Classes as an Assessment Tool*. Participatory Educational Research (PER).

- Enriquez, M. A. S. (2014). *Students' Perceptions on the Effectiveness of the Use of Edmodo as a Supplementary Tool for Learning*. De La Salle University, Manila, Philippines.
- Harrison, C. (2005). *ICT and Classroom Pedagogies. Learning to Teach using ICT in the Secondary School*. Routledge, New York.
- Hart, J. (2015). Top 100 Tools for Learning 2013 In Centre for Learning & Performance Technologies. Retrieved April, 2017, from <http://c4lpt.co.uk/top100tools/>
- Hossain, M. M., & Wiest, L. R. (2013). Collaborative middle school geometry through blogs and other web 2.0 technologies. *Journal of Computers in Mathematics and Science Teaching*.
- Isman, A. (2003). Technology. *The Turkish Online Journal of Educational Technology*. Volume 1, Issue 1, article 1. Available on [www.tojet.sakarya.edu.tr](http://www.tojet.sakarya.edu.tr) or [www.tojet.net](http://www.tojet.net)
- Jegede, P.O. (2008). *ICT attitudinal characteristics and use level of Nigerian teachers*. In *Issues in Informing Science and Information Technology*.
- Kirschner, P. A., & Lai, K. W. (2007). Online communities of practice in education. *Technology, Pedagogy and Education*, 16(2), 127-131
- Lindsay, K. (2006). *Journal Writing to Improve Math Skills* [http://www.glencoe.com/sec/teachingtoday/subject/int\\_writing\\_math.phtm](http://www.glencoe.com/sec/teachingtoday/subject/int_writing_math.phtm)
- Luechefeld, S. (2013), *The use of Edmodo will increase students' achievement by increasing student engagement and decreasing negative behaviors*. <http://prezi.com/pqbl4xzhi72/are-action-research-project/>
- Mahjan, S. (2014). *Mathematics for the 21st Century: What Should Students Learn?*. Center for Curriculum Redesign Boston, Massachusetts. [www.curriculumredesign.org](http://www.curriculumredesign.org). Majid, A. N. (2011). *The use of information technology in teaching English: An attempt to develop student-centered learning at Telkom Polytechnic*.
- Mason, R., & McFeetors, P. (2002). *Interactive writing in mathematics class: Getting started*. Mathematics Teacher.
- Ministry of Education MOE - Singapore. (2000). *Mathematics syllabus (primary)*. Singapore: *Curriculum Planning & Development*.
- Mohamad, S. N. M., Salleh, M. A. M., & Salam, S. (2015). *Factors Affecting Lecturers Motivation in Using Online Teaching Tools*. Procedural-Social and Behavioral Sciences. Mokhtar, F. A. (2016). Rethinking Conventional Teaching in Language Learning and Proposing Edmodo as Intervention: A Qualitative Analysis. *Malaysian Online Journal of Educational Technology*, 4(2), 22-37.
- National Council of Teachers of Mathematics (NCTM). (2000) *Principles and standards for school mathematics*. Reston, VA: Author
- Nool, N. R. (2012a). Effectiveness of an Improvised Abacus in Teaching Addition of Integers. *International Conference on Education and Management Innovation* (Vol. 30, pp. 307-311).
- Nool, N. R. (2012b). Exploring the Metacognitive Processes of Prospective Mathematics Teachers during Problem Solving. In *International Conference on Education and Management Innovation* (Vol. 30, pp. 302-306).
- Parker, R., & Breyfogle, M.L. (2011). *Learning to write about mathematics*. Teaching Children's Mathematics. Retrieved <http://edu316-324-306spr11.wikispaces.com>

Penwell, T., (2011). *The Impact of an Educational Social Network (Edmodo) On the Learning Community*. Retrieved: <http://edu316-324-306spr11.wikispaces.com/>

Ministry of Education, Basic Education 2551

Programme for International Student Assessment (PISA). (2003). *Cycle of the Programme for International Student Assessment (PISA). Mathematics Teaching and Learning Strategies in PISA*.

Pugalee, D. K. (2004). A comparison of verbal and written descriptions of students' problem-solving processes. *Educational Studies in Mathematics*

Pugalee, D. K. (2005). *Writing to develop mathematical understanding*. Norwood, MA: Christopher-Gordon.

Sutton, B. B. (2006). *Pedagogy and Curriculum*. Center for Media in Community, EDC. From: <http://www.digitaldivide.net/news/view.php>. (Retrieved January, 2017).

Thongmak, M. (2013). *Social Network System in Classroom: Antecedents of Edmodo*. Adoption, Journal of e-Learning and Higher Education, Vol. 2013 (2013).

Uzun E. (2015) Students' Attitude Towards Edmodo as a Supplementary Tool for Higher Education. *Computer Education and Instructional Technology Department, Mersin University, Mersin, Turkey*.

Wahyudi, (2008). *What does research say on the use of ICT to improve the teaching and learning of mathematics?* Lokakarya Pembelajaran Matematika Berbasis Teknologi Informasi Yogyakarta: PPPTK Matematika.

Yeo, S. M. & Huat, J. D. (2001). *Using journal writing to understand primary three students' perception of multiplication and division: Case studies*. Retrieved: CRP24\_03FLH\_Conf05(CRPP)\_NgYeo.pdf.



## GUIDELINES FOR CONTRIBUTORS TO INQUEST JOURNAL

The following shall serve as guidelines to all contributors for publication of research articles to the INQUEST journal.

1. All articles must have a high degree of scholarship. The articles may come from research entities to the TSU Annual In-house Review of Completed Researches or from outside contributions.
2. All articles must be approved by the editorial board and by selected referees for publication.
3. The articles may either be written in English or Filipino. All articles written in either languages must be accompanied by an Abstract which is written in English.
4. All contributions must be original.
5. Articles must use APA style sheet.
6. Articles must be typed single-spaced, Times New Roman 12pts on letter sized (8.5x11) paper not more than five pages.

All manuscripts must be e-mailed to [research@tsu.edu.ph](mailto:research@tsu.edu.ph)

1. Articles should not be in PDF files.
2. It is the author's/authors' responsibility to secure permission for the use of copyrighted materials and approval of co-authors for the article to be published.
3. Photographs, tables, line drawing, graphs and illustrations should be clear, of good quality and preferably black and white.
4. Contributions should be accompanied by a short profile of the main author reflecting the present designation of the author, agency, education, and field of specialization.

For research articles coming from In-house reviews, the manuscripts should be revised according to the comments/critiques of the evaluating panel. Deadline of submission of contributions is every end of January publication by the end of the year.



THIS JOURNAL IS PUBLISHED ANNUALLY BY THE  
TARLAC STATE UNIVERSITY RESEARCH OFFICE